

MGate 5101-PBM-MN PROFIBUS Master-to-Modbus TCP Gateway User's Manual

First Edition, August 2012

www.moxa.com/product

MOXA[®]

© 2012 Moxa Inc. All rights reserved.

MGate 5101-PBM-MN PROFIBUS Master-to-Modbus TCP Gateway User's Manual

The software described in this manual is furnished under a license agreement and may be used only in accordance with the terms of that agreement.

Copyright Notice

© 2012 Moxa Inc. All rights reserved.

Trademarks

The MOXA logo is a registered trademark of Moxa Inc.
All other trademarks or registered marks in this manual belong to their respective manufacturers.

Disclaimer

Information in this document is subject to change without notice and does not represent a commitment on the part of Moxa.

Moxa provides this document as is, without warranty of any kind, either expressed or implied, including, but not limited to, its particular purpose. Moxa reserves the right to make improvements and/or changes to this manual, or to the products and/or the programs described in this manual, at any time.

Information provided in this manual is intended to be accurate and reliable. However, Moxa assumes no responsibility for its use, or for any infringements on the rights of third parties that may result from its use.

This product might include unintentional technical or typographical errors. Changes are periodically made to the information herein to correct such errors, and these changes are incorporated into new editions of the publication.

Technical Support Contact Information

www.moxa.com/support

Moxa Americas

Toll-free: 1-888-669-2872
Tel: +1-714-528-6777
Fax: +1-714-528-6778

Moxa Europe

Tel: +49-89-3 70 03 99-0
Fax: +49-89-3 70 03 99-99

Moxa China (Shanghai office)

Toll-free: 800-820-5036
Tel: +86-21-5258-9955
Fax: +86-21-5258-5505

Moxa Asia-Pacific

Tel: +886-2-8919-1230
Fax: +886-2-8919-1231

Table of Contents

1. Introduction	1-1
Overview	1-2
Package Checklist	1-2
Product Features	1-2
2. Hardware	2-1
Function Block	2-2
Power Input and Relay Output Pinouts	2-2
LED Indicators	2-2
Dimensions	2-3
Pin Assignments	2-4
Mounting the Unit	2-4
Specifications	2-5
Reset Button	2-6
3. Getting Started	3-1
Connecting Power	3-2
Connecting PROFIBUS Devices	3-2
Connecting to Network	3-2
First Time MGate Configuration	3-2
MGate Manager Windows Utility	3-2
Network Settings	3-3
Data Transfer	3-3
PROFIBUS Network	3-3
Modbus TCP Configuration	3-3
Configure the MGate	3-3
4. Configuration (MGate Manager)	4-1
Installing the Software	4-2
Starting MGate Manager	4-4
Connecting to the Unit	4-6
Modifying the Configuration	4-6
Configure Device	4-7
Network Settings	4-8
PROFIBUS Settings	4-9
Modbus Settings	4-17
Data Exchange Between Modbus TCP and PROFIBUS	4-20
System Settings	4-23
Load Default	4-26
Monitoring Modbus Activity	4-27
Diagnose	4-29
Create/Modify the Configuration File	4-31
Upgrading Firmware	4-32
Import/Export	4-33
5. Configuration (Web Console)	5-1
PROFIBUS Control (System Management – Maintenance - PROFIBUS Control)	5-2
Ping (System Management – Maintenance – Ping)	5-2
Certificate (System Management –Certificate)	5-2
I/O Data View	5-2
PROFIBUS Live List	5-3
6. Configuration (Text Mode Console)	6-1

1

Introduction

Welcome to the MGate 5101-PBM-MN line of PROFIBUS to Modbus TCP gateways. All models feature easy protocol conversion from PROFIBUS to Modbus TCP.

This chapter is an introduction to the MGate 5101-PBM-MN and includes the following sections:

- **Overview**
- **Package Checklist**
- **Product Features**

Overview

The MGate 5101-PBM-MN is a line of protocol gateways that provides users with the following features:

Protocol conversion between PROFIBUS and Modbus TCP

MGate 5101-PBM-MN series products can be used to connect Modbus TCP and PROFIBUS devices to provide PROFIBUS devices with remote maintenance capability.

Windows utility for easy setup and traffic monitoring

A Windows utility is provided to make configuration and operation of the MGate 5101-PBM-MN as easy as possible. The utility uses TCP/IP network to connect MGate 5101-PBM-MN unit.

Package Checklist

All models of the MGate 5101-PBM-MN series are shipped with the following items:

Standard Accessories:

- 1 MGate 5101-PBM-MN PROFIBUS-to-Modbus TCP Gateway.
- Documentation & Software CD.
- Quick Installation Guide.
- Product warranty statement.

Optional Accessories:

- DR-45-24: 45W/2A DIN-rail 24 VDC power supply with universal 85 to 264 VAC input.
- DR-75-24: 75W/3.2A DIN-rail 24 VDC power supply with universal 85 to 264 VAC input.
- DR-120-24: 120W/5A DIN-rail 24 VDC power supply with 88 to 132 VAC/176 to 264 VAC input by switch.
- WK-36-01: Wall mounting kit

Note: Notify your sales representative if any of the above items is missing or damaged.

Product Features

- Protocol conversion between PROFIBUS and Modbus TCP
- Automatic scan of PROFIBUS devices and easy configuration
- Redundant dual DC power inputs and relay output supported
- Embedded data packet analyzer and diagnostic tool
- Web-based GUI for I/O data visualization
- -40 to 75°C wide operating temperature models available

2

Hardware

The following topics are covered in this chapter:

- ❑ **Function Block**
- ❑ **Power Input and Relay Output Pinouts**
- ❑ **LED Indicators**
- ❑ **Dimensions**
- ❑ **Pin Assignments**
- ❑ **Mounting the Unit**
- ❑ **Specifications**
- ❑ **Reset Button**

Function Block

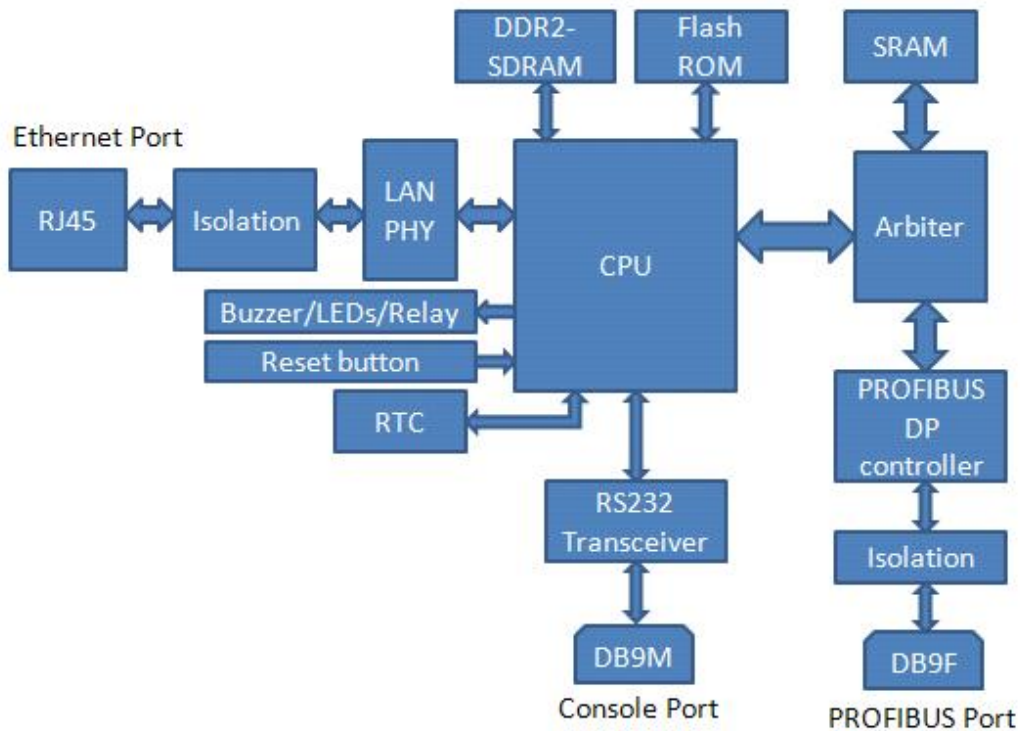

Power Input and Relay Output Pinouts

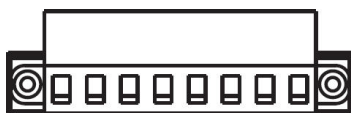

	V2+	V2-				V1+	V1-
Shielded Ground	DC Power Input 2	DC Power Input 2	N.O.	Common	N.C.	DC Power Input 1	DC Power Input 1

LED Indicators

LED	Color	Description
PWR1	Green	Power is on.
	Off	Power is off.
PWR2	Green	Power is on.
	Off	Power is off.
Ready	Green	Gateway is operational.
	Red	Gateway has fault status. This also includes the event is triggered by "Auto Warning" setting such as power lost or Ethernet link down.
	Off	Power is off or fault condition exists.

COMM	Off	No data exchange
	Green	Data exchange with all slaves
	Green, flashing	Data exchange with at least one slave (not all configured slaves can communicate with gateway)
	Red	Bus control error
CFG	Off	No PROFIBUS configuration
	Green	PROFIBUS configuration OK
PBM	Off	PROFIBUS master is offline
	Red	PROFIBUS master is in STOP mode
	Green, flashing	PROFIBUS master is in CLEAR mode
	Green	PROFIBUS master is in OPERATE mode
TOK	Green	Gateway holds the PROFIBUS token
	Off	Gateway is waiting for the PROFIBUS token.
Ethernet	Amber	Steady: 10Mbps, no data is transmitting. Blinking: 10Mbps, data is transmitting.
	Green	Steady: 100Mbps, no data is transmitting. Blinking: 100Mbps, data is transmitting.
	Off	Ethernet cable is disconnected.

Dimensions

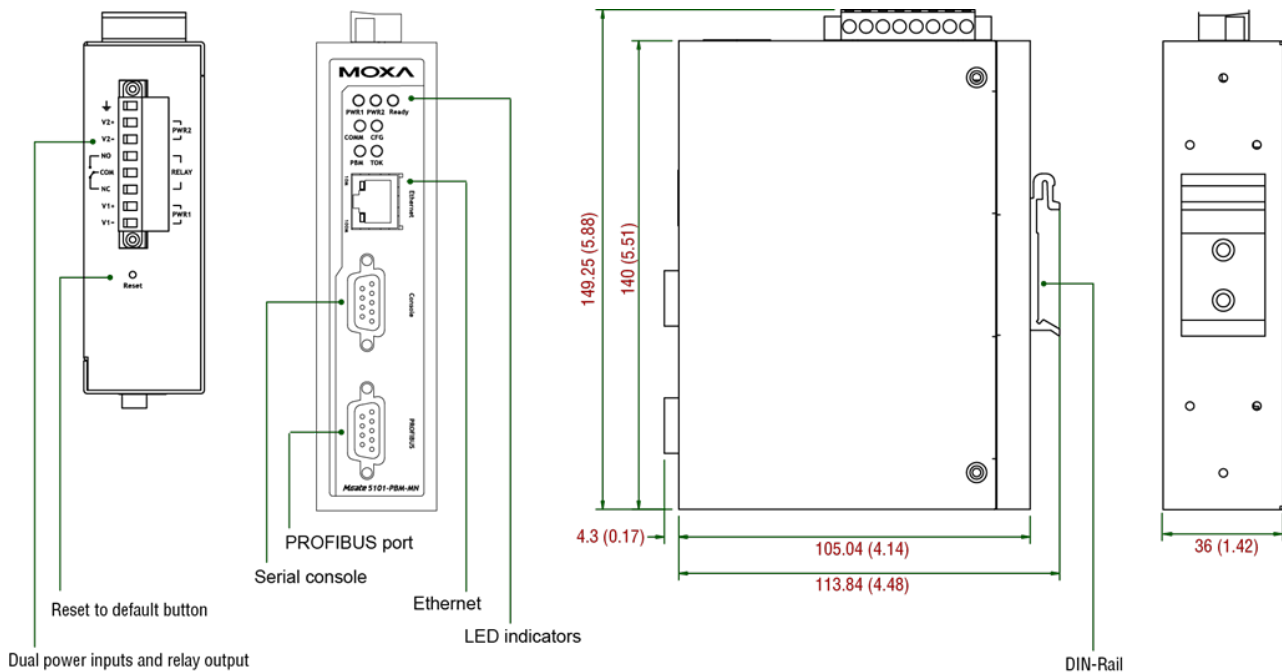

Pin Assignments

PROFIBUS Pin Assignment

The MGate 5101-PBM-MN series use DB9 (female) serial port to connect to PROFIBUS devices.

PIN	Signal Name
1	N.C.
2	N.C.
3	PROFIBUS D+
4	RTS
5	Signal common
6	5V
7	N.C.
8	PROFIBUS D-
9	N.C.

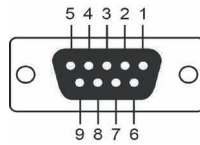

Console (RS-232) Pin Assignment

The MGate 5101-PBM-MN series use DB9 connector to connect to PC to configure device.

Pin	RS-232
1	DCD
2	RXD
3	TXD
4	DTR
5	GND
6	DSR
7	RTS
8	CTS
9	---

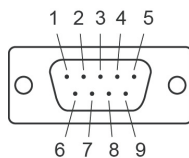

Mounting the Unit

The MGate 5101-PBM-MN series is designed to be attached to a DIN-Rail or mounted on a wall. For DIN-Rail mounting, push down the spring and properly attach it to the DIN-Rail until it “snaps” into place. For wall mounting, install the wall mount kit (optional) first, and then screw the device onto the wall. The following figure illustrates the two mounting options:

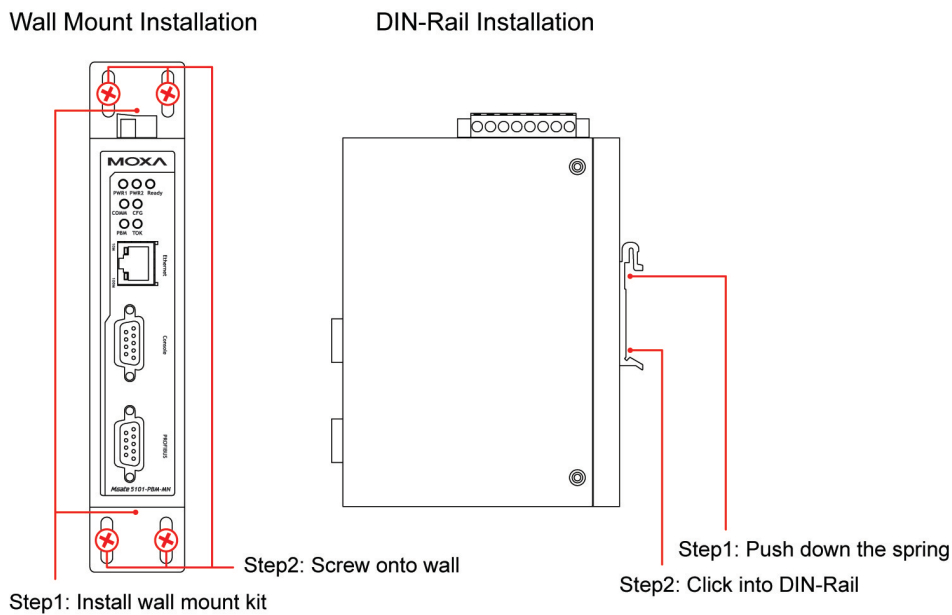

Specifications

Power Input

Input Voltage	12 to 48 VDC
Connector	8-pin terminal block (GND, V1+, V1-, Relay NO, Relay NC, V2+, V2-), screw mounting

Ethernet Interface

Number of Ports	1
Speed	10/100 Mbps, auto MDI/MDIX
Connector	RJ45
Magnetic Isolation Protection	1.5 KV built-in

Serial Console Signals

RS-232	TxD, RxD, RTS, CTS, DTR, DSR, DCD, GND
Connector	Male DB9

PROFIBUS Interface

Protocol	PROFIBUS DP-V1 Master
Data rate	9600 bit/s, 19.2, 93.75, 187.5, 500 kbit/s, 1.5, 3, 6 and 12 Mbit/s
Connector	DB9 female
Isolation	2 KV built-in

Utility

Driver Support	Windows 2000, Windows XP/2003/Vista/2008/7 x86/x64
----------------	--

Physical Characteristics

Housing	Metal, IP30 protection
Dimensions	36 x 105 x 140 mm (1.42 x 4.13 x 5.51 in)

Environmental Limits

Operating Temperature	
Standard Temp. Models	0 to 60°C (32 to 140°F)
Wide Temp. Models	-40 to 75°C (-40 to 167°F)
Operating Humidity	5 to 95% RH
Storage Temperature	-40 to 85°C (-40 to 185°F)

Regulatory Approvals

Safety	UL 60950-1, EN 60950-1
EMC	CE, FCC
EMI	EN 55022 Class A, FCC Part 15 Subpart B Class A
EMS	EN 55024, EN 61000-4-2 (ESD) Level 3,

	EN 61000-4-3 (RS) Level 3,
	EN 61000-4-4 (EFT) Level 4,
	EN 61000-4-5 (Surge) Level 3,
	EN 61000-4-6 (CS) Level 3,
	EN 61000-4-8,
	EN 61000-4-11,
	EN 61000-4-12
Shock	IEC 60068-2-27
Freefall	IEC 60068-2-32
Vibration	IEC 60068-2-6
Reliability	
Alert Tools	Built-in buzzer and RTC (real-time clock)
Warranty	5 years

Reset Button

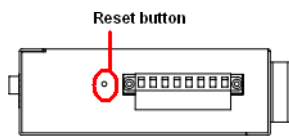

To reset the MGate to the factory default settings, hold down the reset button for about 5 seconds. The MGate will restart and be reset to factory default settings.

The following topics are covered in this chapter:

- ❑ **Connecting Power**
- ❑ **Connecting PROFIBUS Devices**
- ❑ **Connecting to Network**
- ❑ **First Time MGate Configuration**
- ❑ **MGate Manager Windows Utility**
- ❑ **Network Settings**
- ❑ **Data Transfer**
- ❑ **PROFIBUS Network**
- ❑ **Modbus TCP Configuration**
- ❑ **Configure the MGate**

Connecting Power

The unit can be powered by connecting a power source to the terminal block

1. Loosen or remove the screws on the terminal block.
2. Connect the 12–48 VDC power line to the terminal block. Please confirm the power source is off already.
3. Tighten the connections using the screws on the terminal block.
4. Turn on the power source.

Note that the unit does not have an on/off switch. It automatically turns on when it receives power. The PWR LED on the top panel will glow to indicate that the unit is receiving power. For power terminal block pin assignments, please refer to chapter 2 **Power Input and Relay Output Pinout** section.

Connecting PROFIBUS Devices

The unit's PROFIBUS port(s) are located on the front panel. Use a PROFIBUS cable to directly connect the unit to the PROFIBUS devices or PROFIBUS network. Before connecting or removing the PROFIBUS connection, please confirm the power is turned off first.

For the PROFIBUS port pin assignments, please refer to chapter 2 **Pin Assignments** section. This information can then be used to construct users own PROFIBUS cable.

Connecting to Network

Connect one end of the Ethernet cable to MGate's 10/100M Ethernet port and the other end of the cable to the Ethernet network. MGate will indicate a valid connection to the Ethernet in the following ways:

- The Ethernet LED maintains a solid green color when connected to a 100 Mbps Ethernet network.
- The Ethernet LED maintains a solid orange color when connected to a 10 Mbps Ethernet network.
- The Ethernet LED will flash when Ethernet packets are being transmitted or received

First Time MGate Configuration

To configure MGate 5101-PBM-MN properly, there are several basic configurations that users have to do first. User can get a quick overview to make the MGate work properly from the following section. For detail information of each configuration items, please refer the chapter 4 **Configuration**.

MGate Manager Utility

The best way to configure the MGate 5101-PBM-MN is to use MGate Manager. In most cases, users may not know the IP address setting when they get the MGate. For this situation users can use Ethernet cable to connect the host and MGate directly. (Or in the same Ethernet switch. Just make sure there is no router between them) MGate Manager can detect the MGate for users properly. If you want to use web or telnet/SSH console, you have to configure MGate with proper IP address first. It will not be so convenient.

When you can see the MGate is in the MGate Manager devices list, now you can configure it for all options.

Network Settings

The first thing to configure MGate is the network settings for communication. You must to configure the IP address and netmask properly. If you don't know how to configure it, you can contact the IT department for detail configuration. Please refer to chapter 4 **Network Settings** section.

Data Transfer

The second thing is to configure the PROFIBUS and Modbus protocol. MGate provides the internal memory for data transfer between PROFIBUS and Modbus. Both sides will transfer the data between the interface and this internal memory, so users have to understand the structure of this internal memory first. Please refer to the chapter 4 **Data Exchange Between Modbus TCP and PROFIBUS** section. Users have to plan how many data they want to transfer between PROFIBUS and Modbus devices first.

PROFIBUS Network

In PROFIBUS interface, MGate works as the PROFIBUS master. So you have to configure the PROFIBUS network first. Before connecting the slave devices to MGate, users need to configure all slave devices properly such as address and I/O modules. To configure the PROFIBUS slaves for MGate, users can use the AutoScan function in MGate Manager PROFIBUS settings to get all settings of devices which is present on the PROFIBUS network automatically. Please refer to the chapter 4 **PROFIBUS Settings** section. Users also can add the I/O module for each slave devices, and configure the proper internal memory settings manually.

To confirm the PROFIBUS slave devices work properly, users can check the LED in the front panel of MGate. If succeed, the "PBM" LED will show steady green light. To check the I/O module data is exchanged correctly, users can use web console **I/O Data View** to check MGate internal memory. The data which is used by PROFIBUS and Modbus TCP will be displayed for verification.

If any slave devices may not work properly, users will see the "PBM" LED is flashing. Users can use MGate Manager **Diagnose** to check which slave causes the problem. The **Log Settings** function is also another good way to check the communication issue. If any PROFIBUS connection lost, it will record the event into system flash memory for future verification.

Modbus TCP Configuration

In Modbus TCP interface, MGate supports master and slave configurations. Slave mode will be easier to configure. Users need to confirm the Modbus master in remote side can send the command properly. For master mode, users have to specify the command one-by-one manually. Again, users also have to understand the internal memory configuration properly. Please refer to the chapter 4 **Modbus Settings** section.

To check the I/O module data is exchanged correctly, users can use web console **I/O Data View** to check MGate internal memory. Users can use MGate Manager **Diagnose** to check if any Modbus TCP communication issue happened. The invalid response or timeout issue will be displayed in the diagnose window. To confirm the Modbus TCP connections work well, users can use web console to show all the connections information. The **Log Settings** function is also another good way to check the communication issue.

Configure the MGate

MGate 5101-PBM-MN provides four ways to configure the MGate.

1. MGate Manager (Windows utility)

Use MGate Manager to configure the MGate through Ethernet or check the MGate status. Please refer to chapter 4 **Configuration** for detail information.

2. Web console

Use Web console to configure the MGate through Ethernet or verify the MGate status. User can use web browser such as Microsoft Internet Explorer or Google Chrome to connect to MGate with HTTP/HTTPS protocol. In this case the MGate IP address must be configured correctly. Note Web console doesn't provide the interface for all parameters. Some parameters must be configured through MGate Manager. Please refer to chapter 5 **Configuration** for detail information.

3. Text mode console

Use Telnet/SSH console to configure the MGate through Ethernet or verify the MGate status. Users can use the Telnet tool such as HyperTerminal or PuTTY to login to MGate with Telnet or SSH protocol. In this case the MGate IP address must be configured correctly. Note Telnet/SSH doesn't provide the interface for all parameters. Some parameters must be configured through MGate Manager. Please refer to chapter 6 **Configuration** for detail information.

4. Serial console

Use serial console to configure the MGate through RS232 null modem (crossover) cable or verify the MGate status. The interface will be same as Telnet console. Users can use the serial terminal emulation tool such as Moxa PComm Terminal Emulator or PuTTY to login to MGate serial console. Note serial console doesn't provide the interface for all parameters. Some parameters must be configured through MGate Manager. The RS-232 serial console port is located on the unit's front panel. Please refer to chapter 6 **Configuration** for detail information.

Configuration (MGate Manager)

The following topics are covered in this chapter:

- ❑ **Installing the Software**
- ❑ **Starting MGate Manager**
- ❑ **Connecting to the Unit**
- ❑ **Modifying the Configuration**
 - Configure Device
 - Network Settings
 - PROFIBUS Settings
 - Modbus Settings
 - Data Exchange Between Modbus TCP and PROFIBUS
 - System Settings
- ❑ **Load Default**
- ❑ **Monitoring Modbus Activity**
- ❑ **Diagnose**
- ❑ **Upgrading Firmware**
- ❑ **Import/Export**

Installing the Software

The following instructions explain how to install MGate Manager, a utility for configuring and monitoring MGate 5101-PBM-MN units over the network.

1. Insert the Document and Software CD into the CD-ROM drive. Locate and run the following setup program to begin the installation process:

MGM_Setup_[Version]_Build_[DateTime].exe

The latest version might be named MGM_Setup_Verx.x.x_Build_xxxxxxx.exe.

2. You will be greeted by the Welcome window. Click Next to continue.

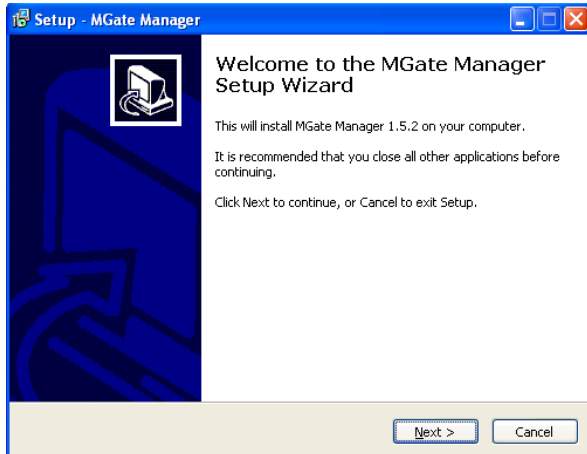

3. When the Select Destination Location window appears, click Next to continue. You may change the destination directory by first clicking on Browse.

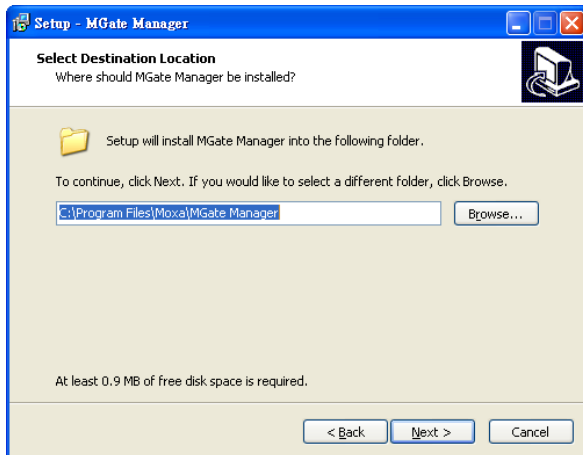

4. When the Select Additional Tasks window appears, click Next to continue. You may select Create a desktop icon if you would like a shortcut to MGate Manager on your desktop.

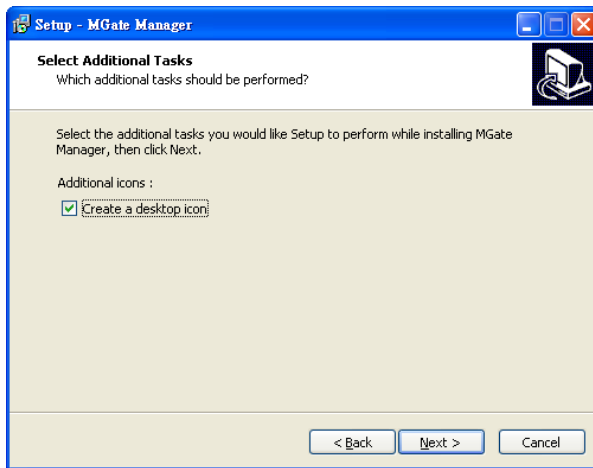

5. Click Next to start copying the software files.

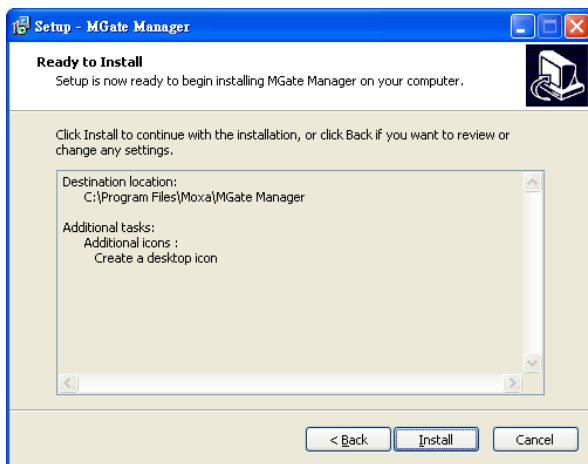

6. A progress bar will appear. The procedure should take only a few seconds to complete.

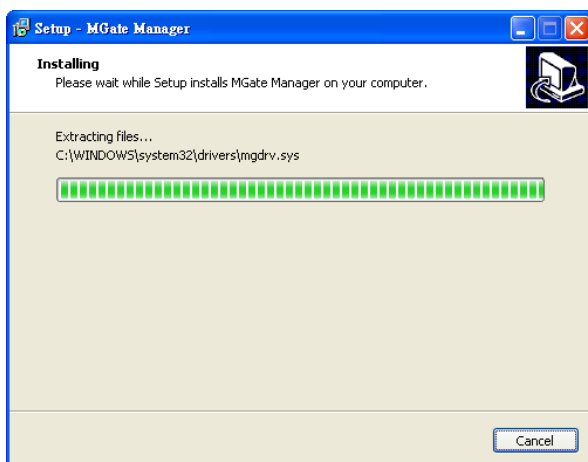

7. A message will indicate that MGate Manager is successfully installed. You may choose to run it immediately by selecting Launch MGate Manager.

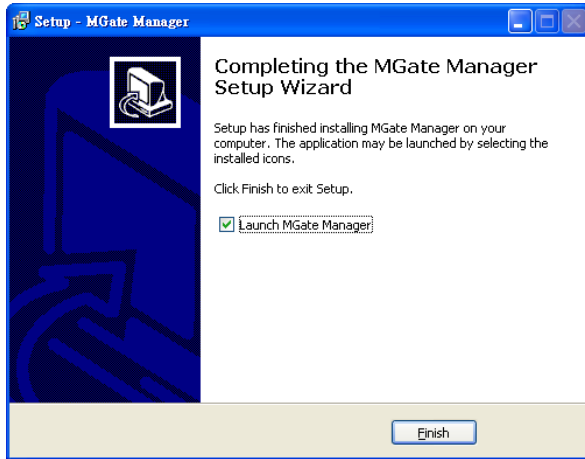

8. You may also open MGate Manager through Start → Programs → MGate Manager → MGate Manager, as shown below.

Starting MGate Manager

MGate Manager is a Windows-based utility that is used to configure the MGate 5101-PBM-MN.

Before running MGate Manager, make sure that the MGate 5101-PBM-MN is connected to your PC. Please refer to Chapter 2 for more details.

You may open MGate Manager from the Windows Start menu by clicking **Start → Programs → MGate Manager → MGate Manager**. The MGate Manager window should appear as shown below.

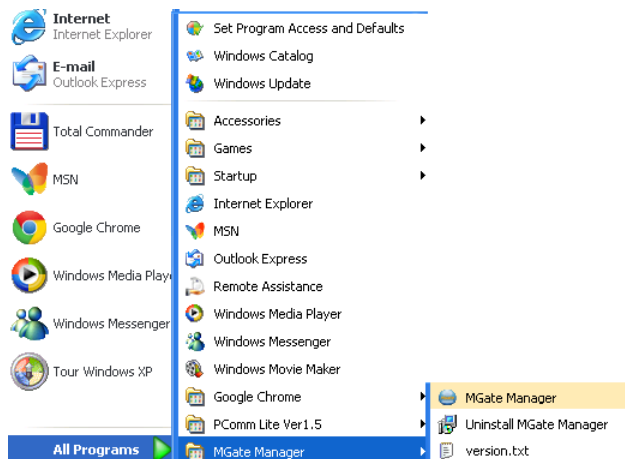

Change Language Setting

If you want to run MGate Manager in a different language, you may click **Language** to change the language setting. A dialog box showing the available languages should appear as shown below.

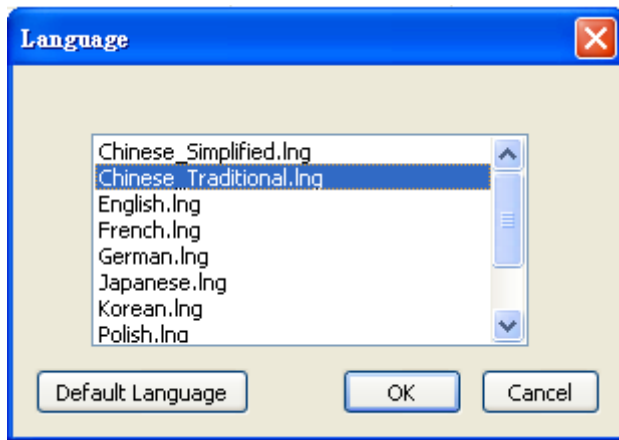

When you click **OK**, MGate Manager will immediately reflect your chosen language.



After changing to a different language, you will find that all strings on MGate Manager are replaced in your chosen language. For example, the above picture is shown in traditional Chinese. Note that no matter what language you choose, it won't change the label on the language button.



ATTENTION

Set your MGate Manager to **"Default Language"** before contacting Moxa Technical Support.

With support for multiple languages, MGate Manager is more user-friendly and accessible. However, if you need assistance from Moxa Technical Support, please change the language to "Default Language". This will prevent any misunderstandings or confusion about MGate Manager menu items and commands as our engineers assist you.

The default language is English and will only be active for the current MGate Manager session. When you open MGate Manager again, the language will revert to your original setting.

Connecting to the Unit

Prior to configuration, MGate Manager must be connected to its unit. There are two methods to establish connection. Broadcast Search locates the MGate series on the LAN. Search by IP attempts to connect to a specific unit by IP address, which is useful if the unit is located outside the LAN or can only be accessed by going through a router.

Broadcast Search

Broadcast Search is used for MGate Ethernet Gateways, such as the MGate 5101/MB3000/EIP3000 series, which are discovered via Ethernet by using broadcast IP.

Specify by IP Address

Specify by IP Address is used for MGate Ethernet Gateways, such as the MGate 5101/MB3000/EIP300 series, which are discovered via Ethernet by using a specific IP address. Click **Specify by IP Address** if you know the IP address of the unit and wish to connect to it directly.



ATTENTION

If Search by IP Address fails to locate the MGate 5101/MB3000/EIP3000 series, the IP address that you entered might be incorrect. Try doing the search again and re-entering the IP address carefully.

Another possibility is that the MGate 5101/MB3000/EIP300 series is located on the same LAN as your PC, but on a different subnet. In this case, you can modify your PC's IP address and or netmask so that it is on the same subnet as the MGate 5101/MB3000/EIP300 series. After your PC and the MGate 5101/MB3000/EIP300 series are on the same subnet, MGate Manager should be able to find the unit.

Modifying the Configuration

Once your unit is displayed in MGate Manager, select it by clicking on it. The Configuration button will become available. Click Configuration to open the configuration window.

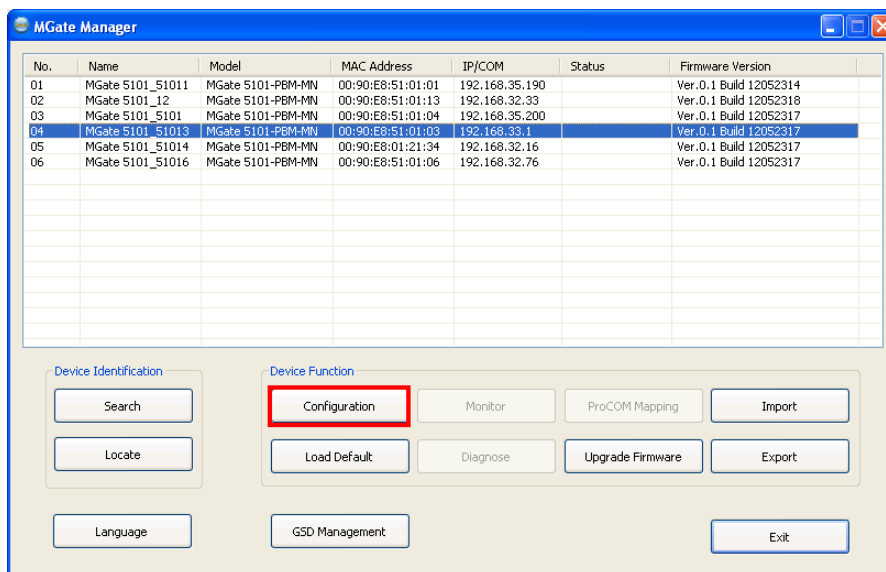

Configure Device

In first page, you can change device name and select a Password to protect the unit from unauthorized access.

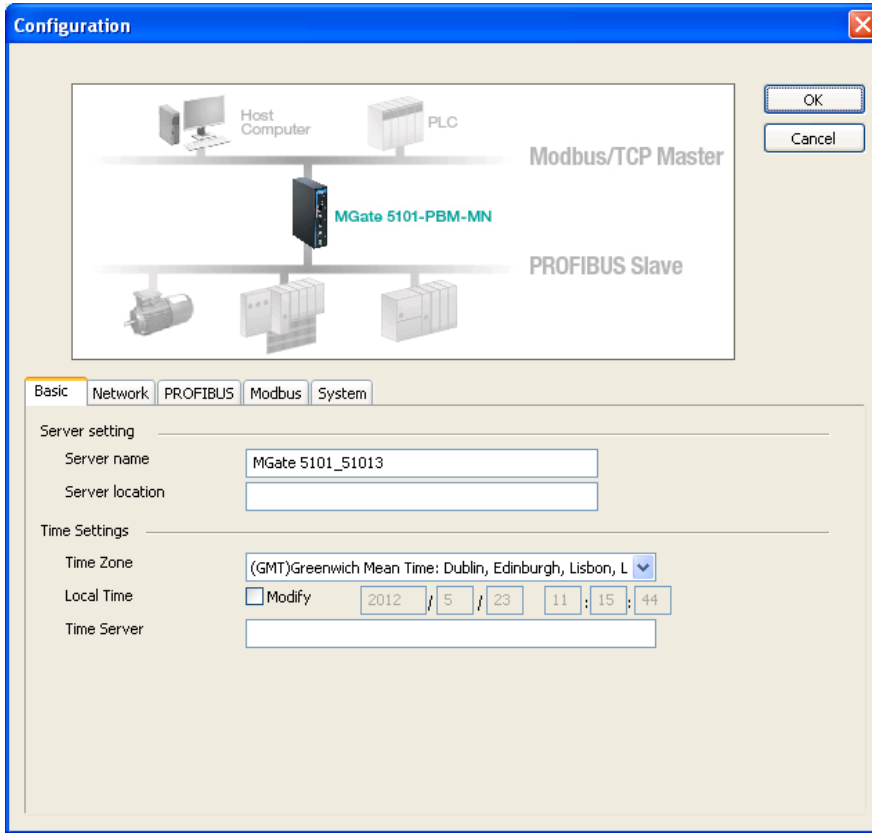

Server Setting

Parameter	Value	Notes
Server Name	(an alphanumeric string)	You can enter a name to help you identify the unit, such as the function, etc.
Location	(an alphanumeric string)	You can enter a name to help you identify the unit location. Such as "Cabinet A001".

Time Settings

MGate 5101-PBM-MN has a built-in Real-Time Clock for time calibration functions. Functions such as log function can add real-time information to the message.



ATTENTION

First time users should select the time zone first. The Console will display the "real time" according to the time zone compared to GMT. If you would like to modify the real time clock, select "Local time." MGate's firmware will modify the GMT time according to the Time Zone.

Parameter	Value	Notes
Time Zone	User selectable time zone	This field shows the currently selected time zone and allows you to select a different time zone.
Local Time	User adjustable time. (1900/1/1-2037/12/31)	

Time Server	IP or Domain address (E.g., 192.168.1.1 or time.stdtime.gov.tw)	This optional field specifies your time server's IP address or domain name, if a time server is used in your network. The module supports SNTP (RFC-1769) for automatic time calibration. The MGate will request time information from the specified time server every 10 minutes.
-------------	--	---



ATTENTION

When modifying the local time, select the time zone first. The time display will be updated to reflect the specified time zone.

Network Settings

The Network tab is where the unit's network settings are configured. You can modify the IP Configuration, IP Address, Netmask, Default Gateway, and DNS.

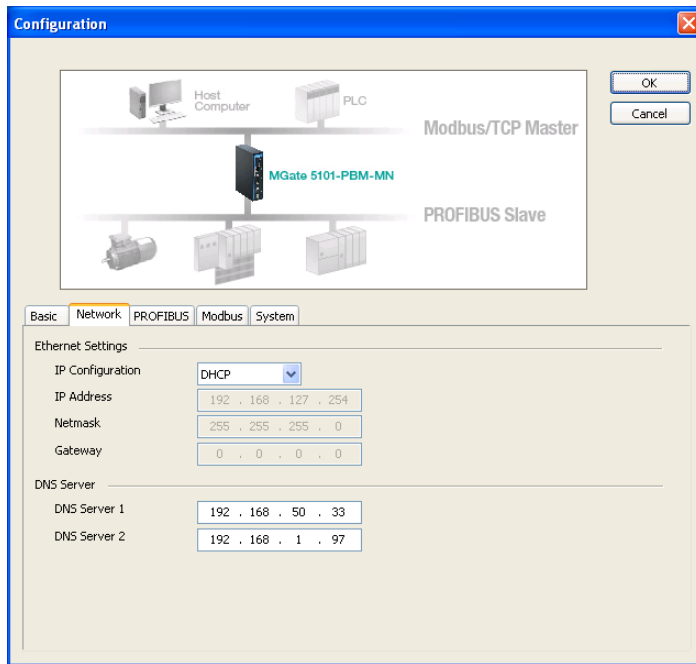

Ethernet Settings

Parameter	Value	Notes
IP Configuration	Static IP, DHCP, BOOTP	Select "Static IP" if you are using a fixed IP address. Select one of the other options if the IP address is set dynamically.
IP Address	192.168.127.254 (or other 32-bit number)	The IP (Internet Protocol) address identifies the server on the TCP/IP network.
Netmask	255.255.255.0 (or other 32-bit number)	This identifies the server as belonging to a Class A, B, or C network.
Gateway	0.0.0.0 (or other 32-bit number)	This is the IP address of the router that provides network access outside the server's LAN.

DNS Server

Parameter	Value	Notes
DNS Server 1	0.0.0.0 (or other 32-bit number)	This is the IP address of the primary domain name server.
DNS Server 2	0.0.0.0 (or other 32-bit number)	This is the IP address of the secondary domain name server.

PROFIBUS Settings

MGate 5101-PBM-MN PROFIBUS interface supports DPV1 master protocol and is compliant with IEC 61158. Before MGate can communicate with PROFIBUS slave devices, users have to input the PROFIBUS parameters for all connected devices such as slave address, I/O module. To configure the slave devices, please click the **PROFIBUS Settings** button. The new configuration window for PROFIBUS network will be opened.

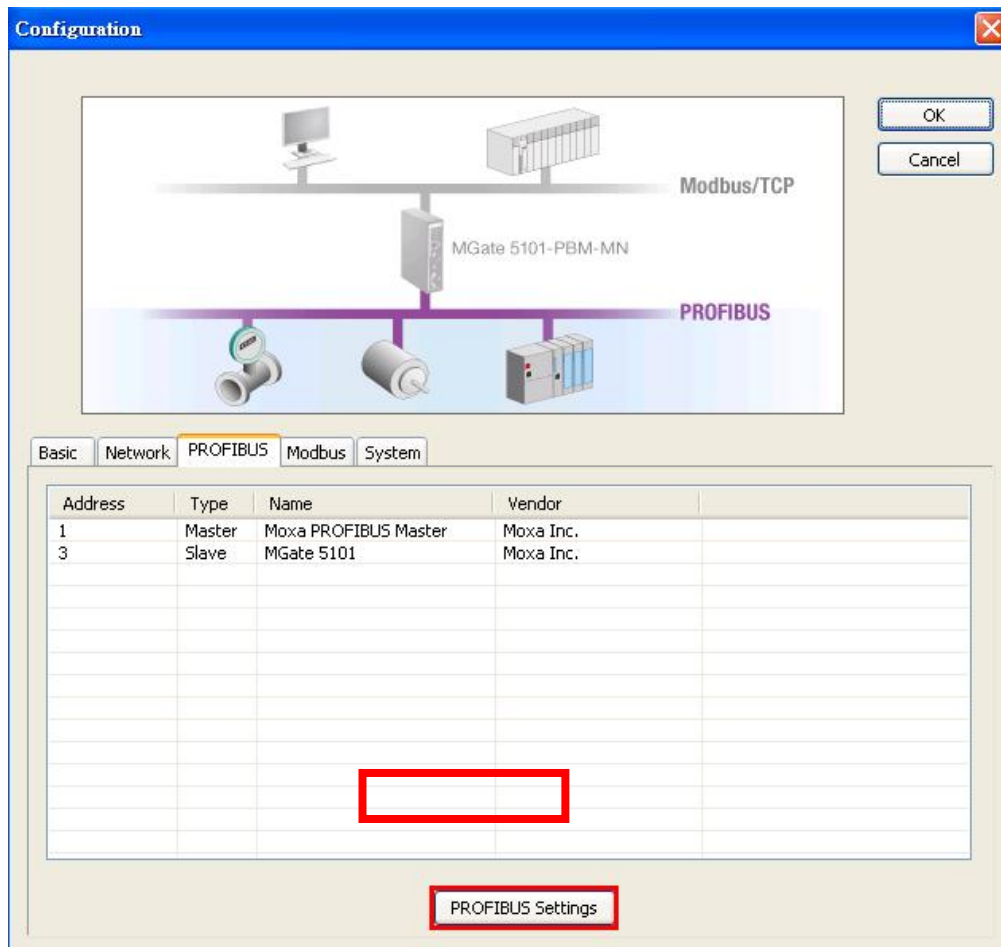

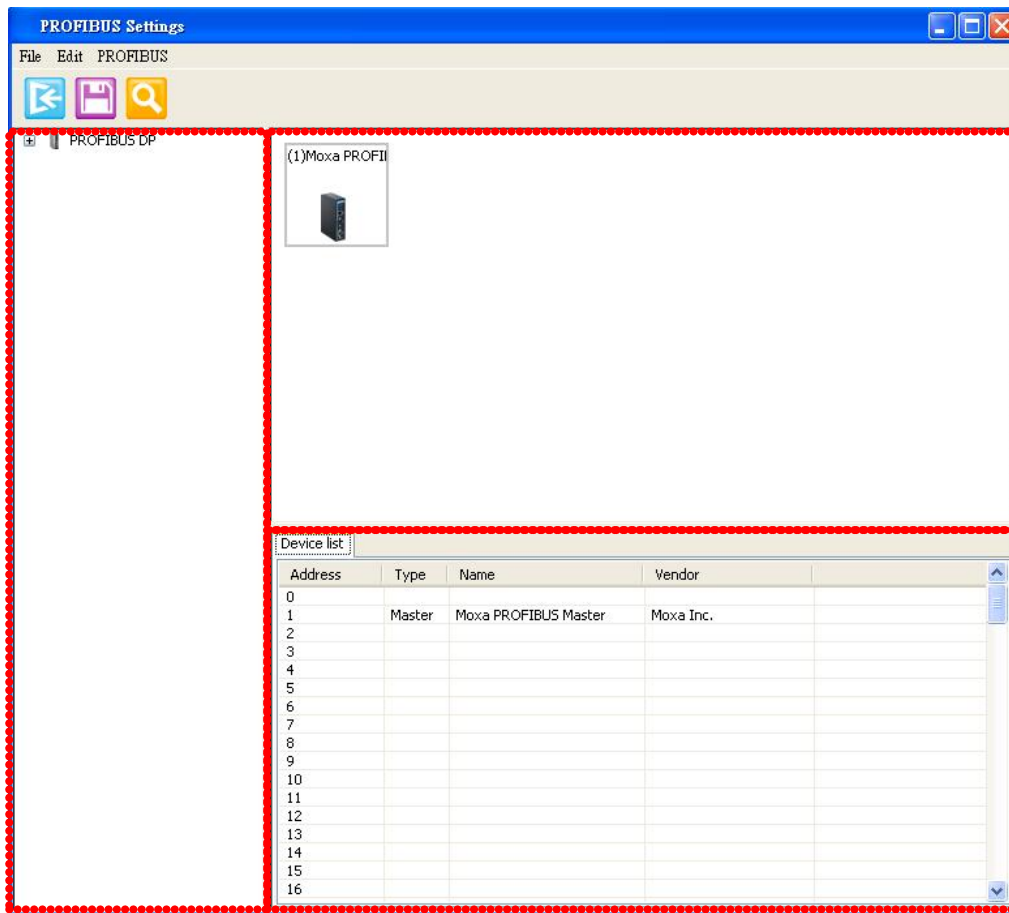

In the PROFIBUS Settings window, user will see 3 areas.

For left panel, it shows a tree list for recognized devices which the GSD file is already import into host computer through MGate Manager. If the target PROFIBUS slave devices which users want to connect to this MGate are not in the list, user have to import the GSD file first.

For right top panel, it shows the PROFIBUS network which controlled by this MGate. At beginning, there is only one device – PROFIBUS master device, which also means this MGate the user is configuring. To add new devices into this network, users can drag the device from the left panel and put it into this panel. To have this device work correctly, users have to configure the PROFIBUS parameters of this device such as slave address and baud rate.

For right bottom panel, it shows the “device lists” or “the “I/O module list of the selected slave device on the top panel”.

Add new PROFIBUS slave devices into the PROFIBUS network

1. Add new GSD file for different PROFIBUS slave device through GSD management function. If several devices use the same GSD file, users only need to run this process once. That means if the GSD file is already in the GSD Management window list, users can skip this step.
2. Load PROFIBUS Settings window.
3. Add new device into PROFIBUS network.
4. Configure the PROFIBUS address.
5. Configure the I/O module for the target PROFIBUS slave device which users want to access.
6. Run step 3 to 5 for each PROFIBUS slave device.
7. Save the configuration and exit the PROFIBUS Settings function.

Step1: Add new GSD file if necessary

GSD (General Station Description) file is a standard device description file for PROFIBUS device. It includes all important device information and is provided by manufacturer. If users want to configure a PROFIBUS device into one PROFIBUS network, users have to get the GSD file and import into the PROFIBUS network configuration software. In MGate Manager, it provides a function to complete the GSD management.

Please click the "GSD Management" bottom in the MGate Manager main window.

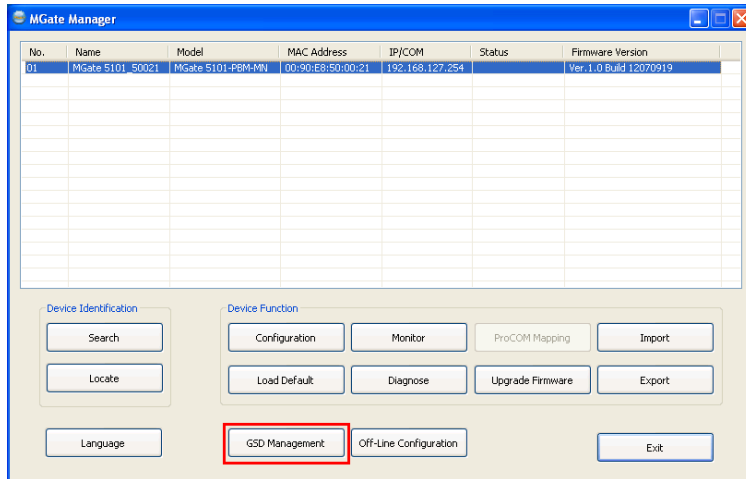

The GSD management window will be displayed. To add the new GSD file into MGate Manager, please click Add bottom and specify the directory of the device GSD file.

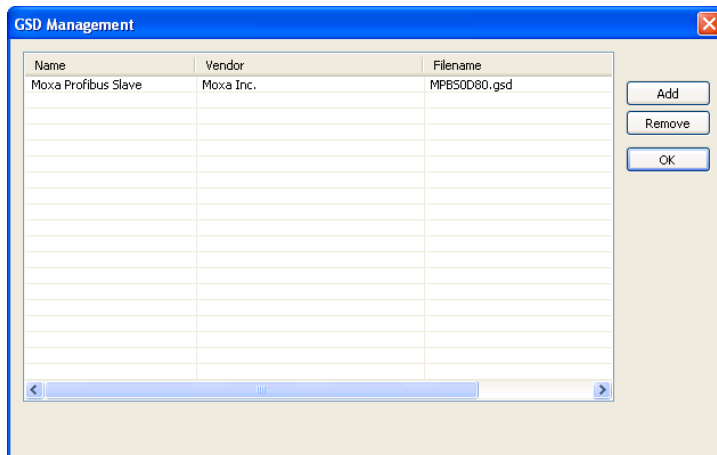

Step2: Load the PROFIBUS Settings window

Please refer to the procedure at the beginning of this section.

Step3: Add new device into PROFIBUS network

If users already add the device GSD file into MGate Manager correctly, users should see the device listed in the left panel tree.

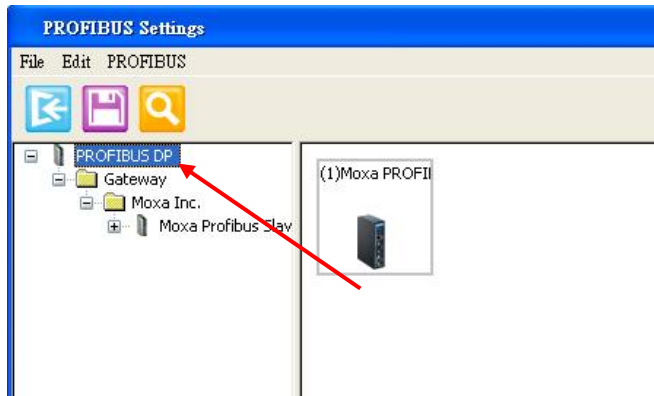

To add the device into the PROFIBUS network in the right top panel, users can use mouse the drag the device into the right panel. And user will also see the device lists in the right bottom panel.

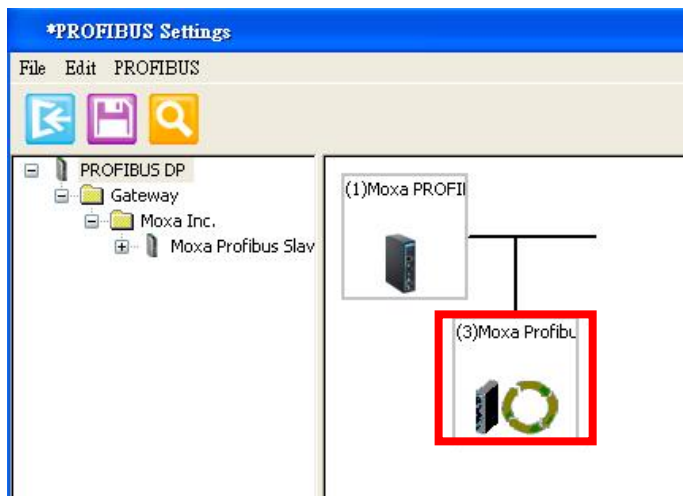

To remove the device from the PROFIBUS network in the right top panel, users can click the device and press the delete key.

AutoScan Function

MGate Manager also supports PROFIBUS Automatic scan function. Please click "AutoScan" button and MGate will display all devices on the PROFIBUS network with configured I/O modules in a new window. You can click the top check box to select all, or just click each check box for signal device. When you click OK button, the selected device and relative I/O module will be added into PROFIBUS network configuration. With this function you don't need to configure the slave devices one by one manually. But you have to configure each slave device properly first such as slave address and I/O modules

When you use this function, you can go to Step 7 directly.

<input type="checkbox"/> Device status	Addr...	Iden...	Model name	Vendor	Module	GSD file
<input type="checkbox"/> Master in bus configuration	1	0x0DF3	Moxa PROFIBU...	Moxa Inc.	-	MPBM0DF3.gsd
<input type="checkbox"/> Slave not in bus configuration	2	0x0D80	Moxa Profibus ...	Moxa Inc.	Input: 64 Words Output: 64 Words Input: 32 Words Output: 32 Words	MPBS0D80.gsd

Step 4: Configure the PROFIBUS device address and other parameters if necessary.

User can click different device to see different parameter configuration window in the bottom panel. In the configuration window, user can click different tab to configure the detail parameter for each device, including the PROFIBUS master.

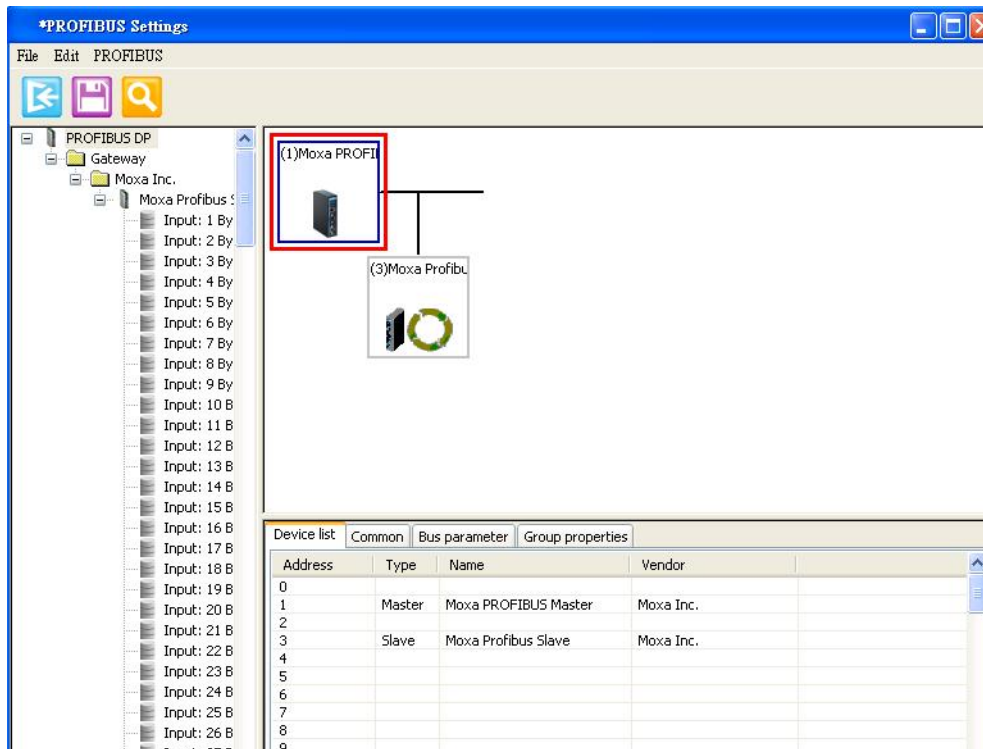
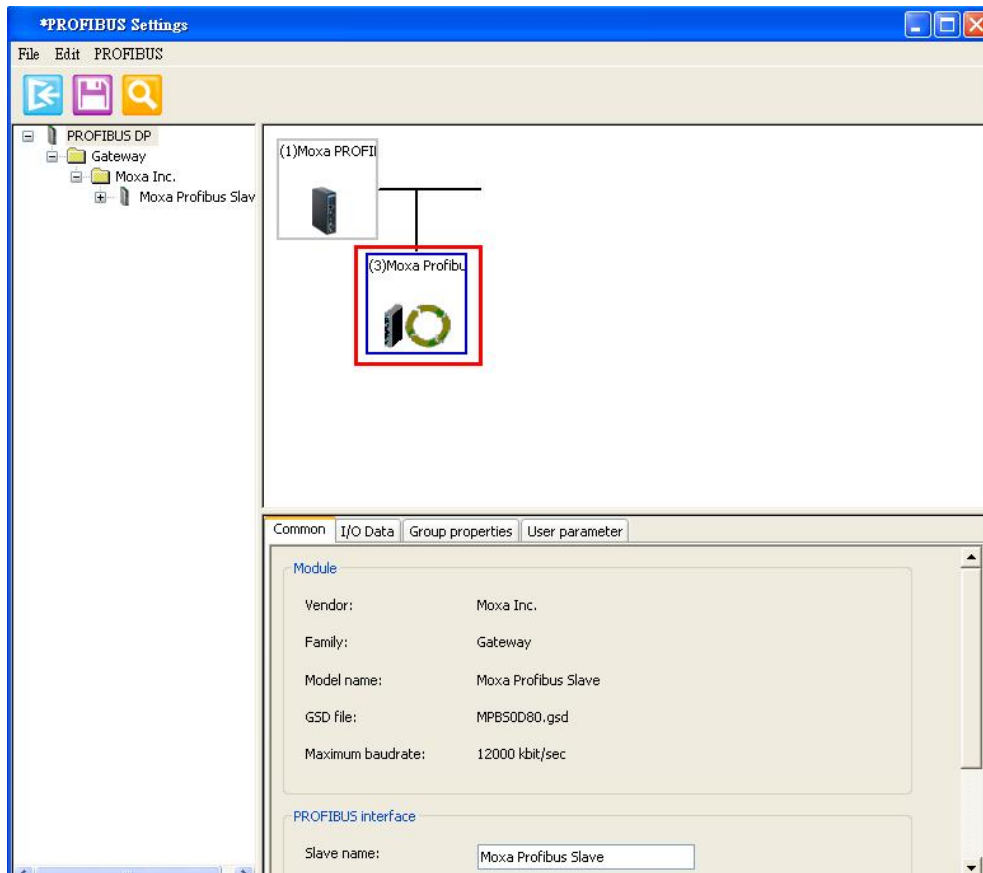

Step 5: Configure the I/O module for the target PROFIBUS slave device which users want to access.

To configure the PROFIBUS I/O modules for target slave device, user can click the device in the top panel and click the "I/O data" tab in the bottom panel. Users can drag the proper I/O module from the left panel to the right panel to complete the configuration.

Users also need to configure the device parameter including the slave address and I/O modules. To configure each I/O module in detail, users can double click the I/O module and the configuration dialog will be displayed. In the dialog, users can configure the internal memory address offset and Fault value. For these parameters configuration, please refer to the "Data Exchange Between Modbus TCP and PROFIBUS" and "Fault Value Configuration in PROFIBUS output module".

To remove the I/O modules, please click the I/O module and then press the delete key.

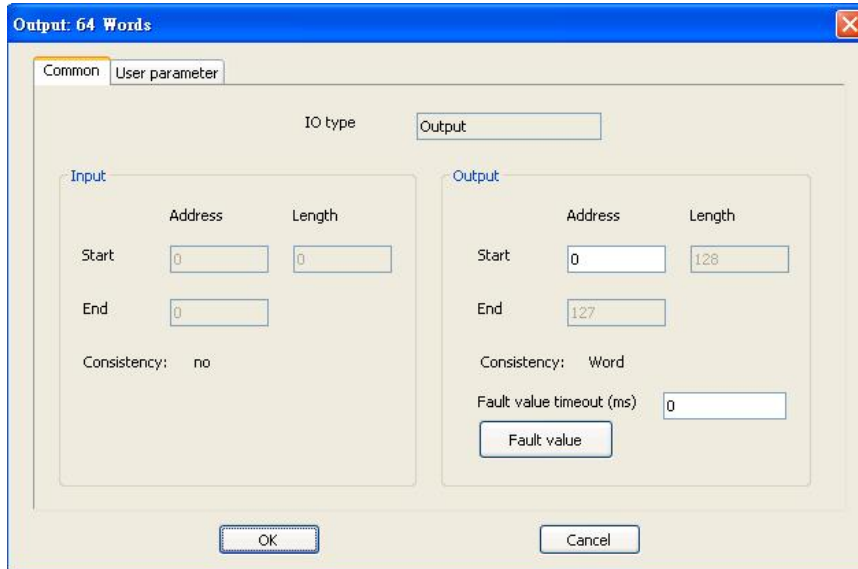
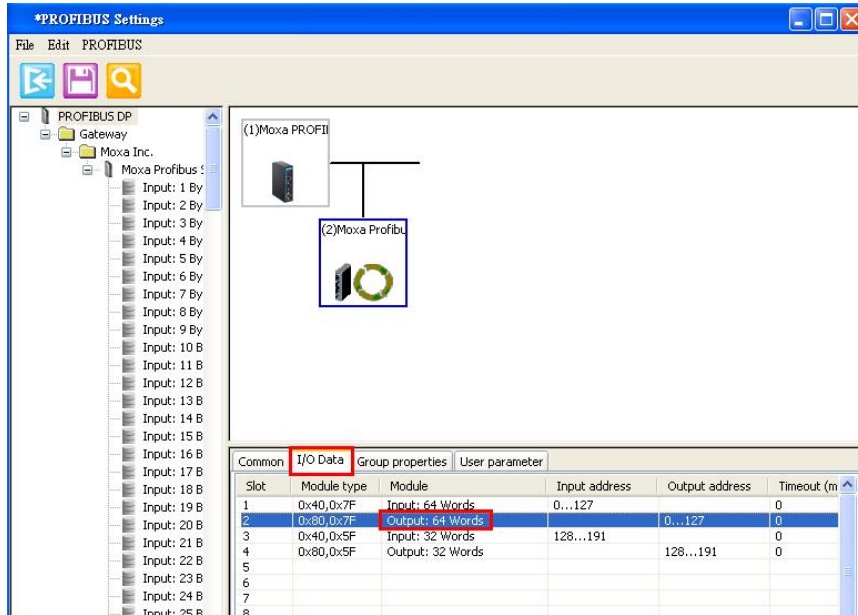

Step 6: Run step 3 to 5 for each PROFIBUS slave device.

In this step, users have to confirm the PROFIBUS addresses have no conflict.

Step 7: Save the configuration and exit the PROFIBUS Settings function.

To save the PROFIBUS network configuration, users have to click the save button in the toolbar. Then all settings will be stored into the MGate device.

The MGate device will save the new settings and reboot to activate the settings.

Fault Value Configuration in PROFIBUS output module

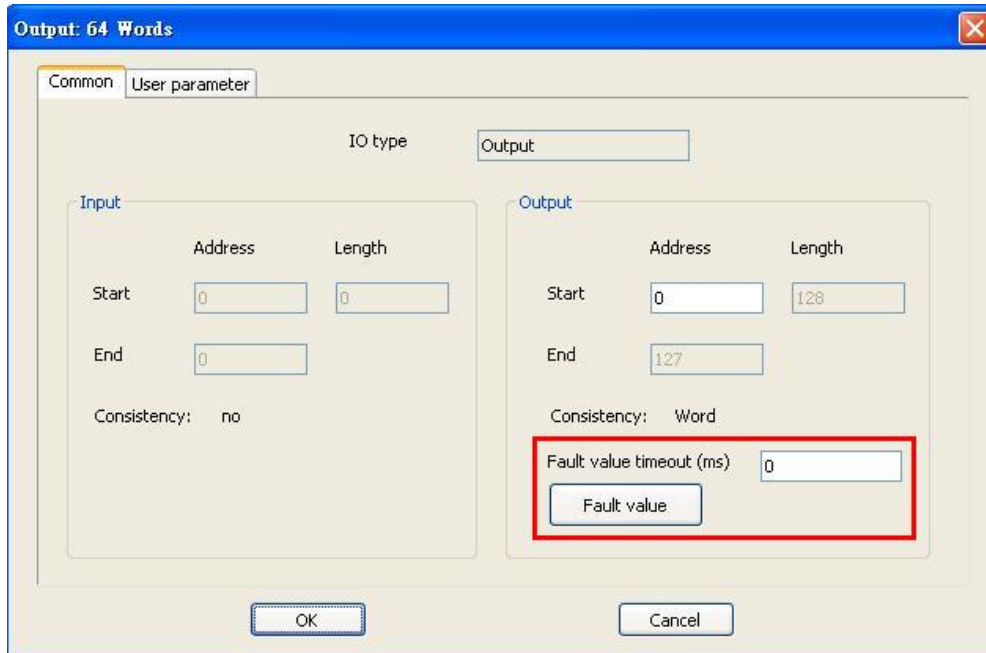

In some application, users want to define how to deal with the PROFIBUS output when Modbus TCP side doesn't work well. This is defined as the "Fault value". In MGate, it provides a setting for each PROFIBUS I/O module to handle such situation.

User must specify the fault value for each byte. The trigger point is depended on the timeout. For each I/O module, it is linked to an internal memory block and it should be updated by Modbus TCP periodically. If this block is not updated/accessed within defined timeout period by any Modbus TCP command, MGate will set the PROFIBUS output with the "Fault value" setting or do nothing if the timeout is set to zero.

To configure the Fault Value, users can double click the I/O module. The I/O module configuration dialog will be displayed and the Fault Value configuration is in output module configuration.

Fault value timeout: 0, 100~60000(ms). If the specific internal memory is not updated within this timeout, MGate will set the PROFIBUS value with the "Fault value" setting. If this timeout value is zero or not within 100 to 60000, the setting will be ignored. And MGate will not monitor this memory block.

Fault value: The PROFIBUS output will be set to this value when the specific internal memory is not updated within specific time (defined in the below timeout value). MGate will monitor all Modbus activities to see which internal memory is accessed. Even though some memory keeps the same value, MGate will reset the timeout if any access on this memory block. Any access means the Modbus TCP work well.

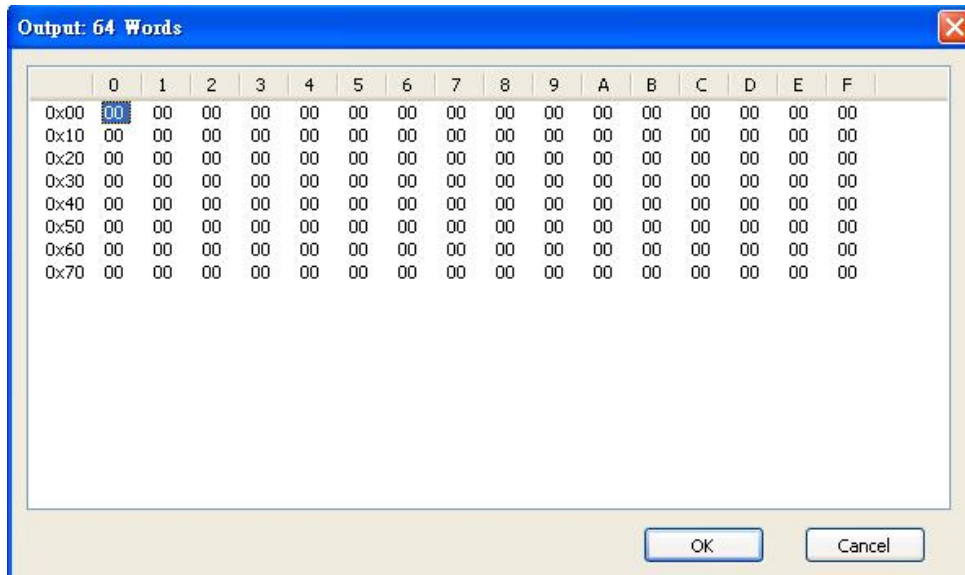

Note: If you want PROFIBUS output to keep the last value when Modbus TCP has any problem, you can set this timeout value to zero.

PROFIBUS Parameters

For PROFIBUS interface, there are also several parameters can be configured manually. These parameters are showed at below configuration page.

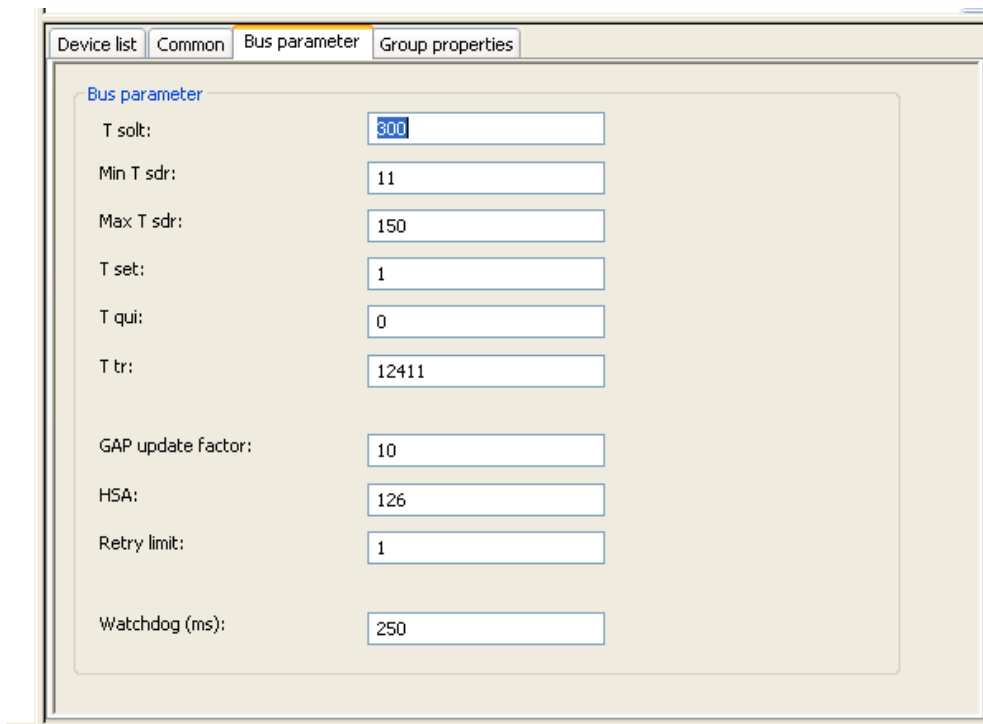

Timing settings

Parameter	Value	Notes
T Slot	The unit is 100us.	The maximum time that the PROFIBUS master must wait for slave response.
Min T SDR	The unit is bits time. Range from 11 to 255.	The minimum delay time that the PROFIBUS slave device reply the master request.
Max T SDR	The unit is bits time. Range from 11 to 255.	The maximum delay time that the PROFIBUS slave device reply the master request.
T set		Setup time. The time between an event and reply message.
T qui		Quiet Time. The time a slave device must wait after the end of a frame before enabling its receiver.
T tr		Target rotation time. The anticipated time for one token rotation on this PROFIBUS System including allowances for high and low priority transactions, errors and GAP maintenance.
GAP update factor		The number of token rounds between GAP maintenance (update) cycles.
HSA		Highest Station Address (FDL Address)
Retry limit		The maximum PROFIBUS retry count.
Watchdog (ms)		The watchdog time will be transferred to slave in Set Parameter stage. The watchdog control in a DP-Slave takes care of that, if the master fails, the outputs fall in the safe state after the expiration of this time.

SYNC and FREEZE Settings

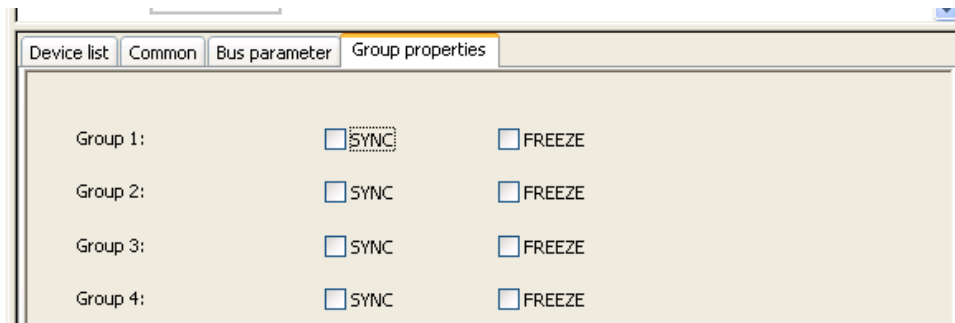

SYNC: In data_exchange the previous output value will be transferred. The following output data will be stored and not be transferred until next SYNC command or UNSYNC command.

FREEZE: In data_exchange the last input value will be transferred. The following input data value will be stored into special buffer and will not be transferred.

Modbus Settings

MGate 5101-PBM-MN support Modbus TCP function slave and master mode. For slave mode, MGate works as a server and waits for incoming connection from Modbus TCP master. And for master mode, MGate works as a client and will try to build a TCP connection with remote Modbus TCP device. In this mode, users have to specify the IP address of the remote device and the relative Modbus command.

Slave Mode Settings

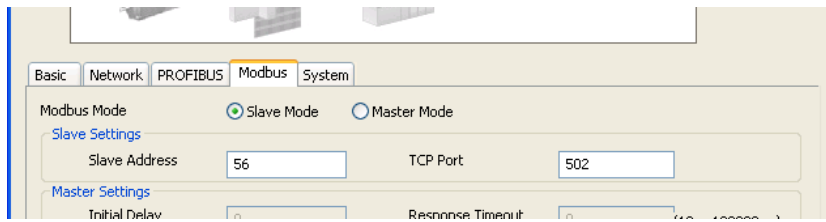

Parameters	Value	Description
Slave Address	1 to 255	The Modbus address of this MGate.
TCP Port	0 to 65535	The local TCP port for this MGate.

Master Mode Settings

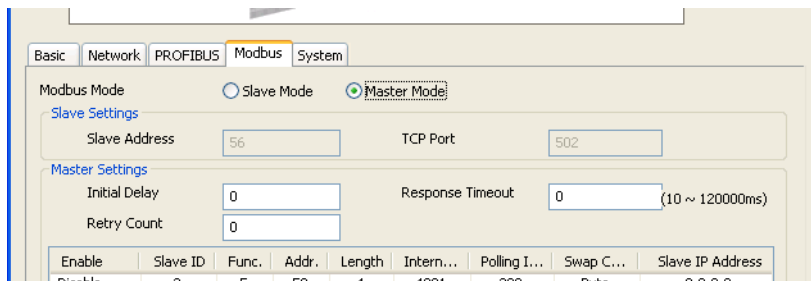

Parameters	Value	Description
Initial Delay	0 to 65535ms	Some Modbus slaves may take more time to boot up than other devices. For certain environments, this may cause the entire system to suffer from repeated exceptions during the initial boot-up. You can force the MGate to wait after booting up before sending the first request with the "Initial Delay" setting.
Response Timeout	10 ~12000ms	This is used to configure how long the MGate will wait for a response from a Modbus slave.
Retry Count	0 to 99	This is used to configure how many times the MGate will try to communicate with the Modbus slave.

Modbus Command Table

To communicate with remote Modbus TCP slave device, users have to specify the Modbus command for each device. For each Modbus read/write command, users also have to specify the internal memory address for data exchange. For read command, the received information from remote device will be updated into the specified internal memory address. For write command, the data in the specified internal memory address will be sent to remote device. The data will be used to update remote device register.

Each remote device may need more than one command to communicate, so users have to input all the commands manually.

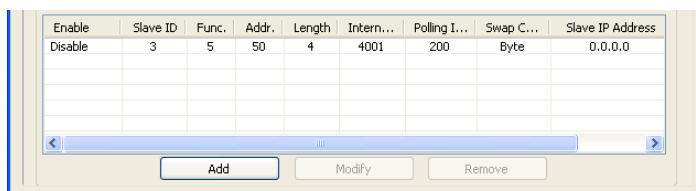

When users click Add or Modify button, the following dialog will be displayed for configuration.

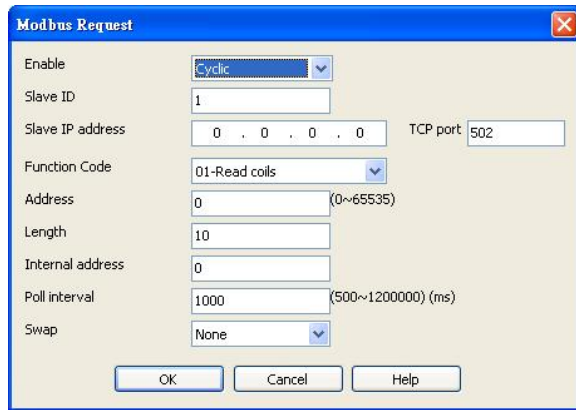

Parameters	Value	Description
Enable	Disable/Cyclic/Data Change	The Enable for the transaction: Disable: The transaction is never sent Cyclic: The transaction is sent cyclically at the interval specified in the "Poll Interval" parameter. Data change: The data area is polled for changes at the time interval defined by Poll Interval. A transaction is issued when a change in data is detected.
Slave ID	0 to 255	The Modbus slave id that this slave module will accept. 0: Broadcasting 1~255: Device specific
Slave IP Address	IP address.	The IP address of remote slave device
TCP Port	0 to 65535	The TCP port number of remote slave device.
Function Code	01,02,03,04,05,06,15,16	When a message is sent from a Master to a Slave device the function code field tells the Slave what kind of action to perform. We support the following function code by far: 01: Read coils 02: Read discrete inputs 03: Read holding registers 04: Read input register 05: Write single coil 06: Write single register 15: Write multiple coils 16: Write multiple registers
Parameters	Value	Description
Address	0 to 65535	Station Address.
Length		The length field is a byte count of the following fields, including the Unit Identifier and data fields.
Internal address		This parameter specifies the location of the trigger byte in internal memory.
Poll interval	500 to 1200000ms	Polling interval in millisecond, since the module sends all requests in turns, the actual polling interval also depends on the number of requests in the queue and their parameters.
Swap	None, Byte, Word, ByteWord	Data Byte Swapping None: Don't need to swap

		<p>Byte: 0x0A, 0x0B, 0x0C, 0x0D becomes 0x0D, 0x0C, 0x0B, 0x0A.</p> <p>Word: 0x0A, 0x0B, 0x0C, 0x0D becomes 0x0C, 0x0D, 0x0A, 0x0B.</p> <p>ByteWord: 0x0A, 0x0B, 0x0C, 0x0D becomes 0x0D, 0x0C, 0x0B, 0x0A.</p> <p>There are two phases in changing ByteWord</p> <p>1). 0x0A, 0x0B, 0x0C, 0x0D becomes 0x0B, 0x0A, 0x0D, 0x0C.</p> <p>2). 0x0B, 0x0A, 0x0D, 0x0C becomes 0x0D, 0x0C, 0x0B, 0x0A.</p>
--	--	--

To remove a Modbus command, click the specified command and then click the remove button.

Data Exchange Between Modbus TCP and PROFIBUS

MGate provides the internal memory to achieve the data exchange between Modbus and PROFIBUS. For both sides, the internal memory data will be used as the new data to send to connected device. For example, the Modbus function 06 - write holding register is to write a word into the register in device. In MGate, users can specify this command to use specified internal memory data as the new data. For PROFIBUS, the output I/O module will use the same way to retrieve the data from internal memory to write new data into remote device. The received data will also be put into the internal memory for Modbus read command and PROFIBUS input I/O modules.

To configure the internal memory, users have to understand the internal memory structure first. MGate internal memory is divided into two parts: one for input direction and another for output. Input means to transfer data from PROFIBUS side to Modbus TCP. Output means opposite direction. Please see below picture.

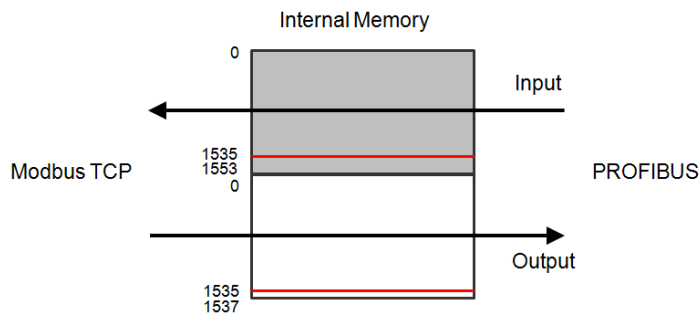

Internal Memory Address

The MGate 5101-PBM-MN can support up to 1536 bytes input and 1536 bytes output data. Input addresses 1536-1553 are reserved for checking PROFIBUS Master or Slave status. Output addresses 1536-1537 are for changing the PROFIBUS Master status. Please see table below.

Input Data Memory

0 - 1535	Input data	
1536 - 1537	Status word	bit1:0 = Master Mode 00: Offline 01: Stop 10: Clear 11: Operate bit15:2 reserved
1538 - 1553	Communication list	1538: bit 0..7 = Slave 0..7 1539: bit 0..7 = Slave 8..15 ... 1553: bit 0..5 = Slave 120..125 bit SET → Slave is in data exchange bit CLEAR → Slave in not in data exchange

Output Data Memory

0 - 1535	Output data	
1536 - 1537	Control word	bit1:0 = Master Mode 00: Reserved 01: Stop 10: Clear 11: Operate bit15:2 reserved

Internal Memory Configuration for PROFIBUS I/O module

For PROFIBUS, users will see the assigned internal memory address in MGate Manager PROFIBUS Settings window. The "Input addr." means the offset address in internal memory for input direction. The "Output addr." means the offset address in the internal memory for output direction. This address is assigned by MGate Manager automatically when the I/O module is just created, but users can modify it manually. In such case, users have to confirm the new offset has no overlap with other I/O modules.

Note the unit of the offset is byte. This is different from the Modbus TCP configuration.

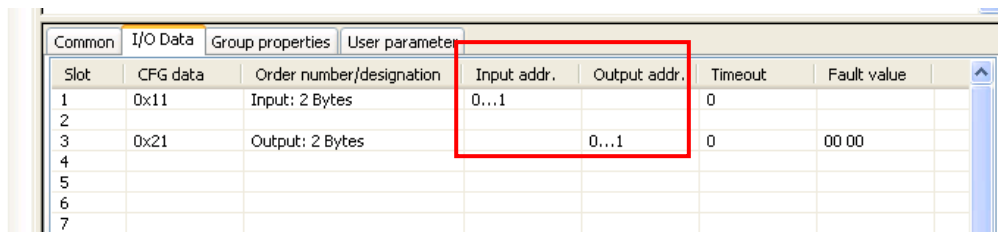

Internal Memory Configuration for Modbus TCP Master mode

There are two different modes in Modbus TCP side: the slave mode and master mode. For Maser Mode, the internal memory configuration is in the Modbus command edit dialog.

The following is the example to demo the concept. Users configure the I/O as below table. To use the input data to update the remote Modbus TCP device, users use 06-write single register with 2 bytes. The "Internal address" can refer to the I/O module setting, so users use 8 in this example. That means this command will retrieve the data in offset address 8 of internal memory as the new data to update remote device. And the data in this address will be updated cyclically by the PROFIBUS I/O module as you can see below. Because users want to transfer the 4 bytes data, in Modbus that means it is two registers length.

About the output direction, we use the same way to configure the Modbus TCP command.

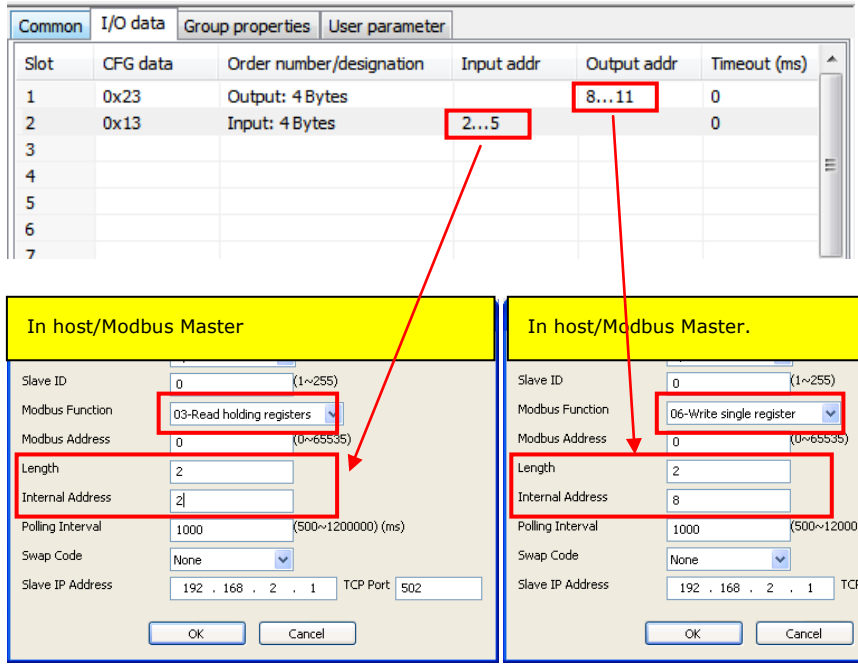

Internal Memory Configuration for Modbus TCP Slave Mode

In slave mode, users don't need to configure any Modbus command settings the MGate, but users have to know how to send the right Modbus TCP command to MGate. In Modbus, users can request the register data or bit data. For register data, the length is two bytes with 16 bits. For bit data, the length is 1 bit. So there are 01, 02, 05, 15 Modbus command support bit access, and 03, 04, 06, 16 command support register access.

If you want to access the (n)th bit data in MGate internal memory offset (N) with Modbus bit access command: For bit access, the Modbus address should be **$N*8*2+n+1$** . (**N, n is zero based**)

If you want to access the data in MGate internal memory offset (N) with Modbus register access command: For register access, the Modbus address should be **$N/2+1$** .

Slot	CFG data	Order number/designation	Input addr.	Output addr.
1	0x11	Input: 2 Bytes	0...1	
2	0x13	Input: 4 Bytes	8...11	
3	0x21	Output: 2 Bytes		0...1
4	0x23	Output: 4 Bytes		2...5
5				
6				
7				
8				
9				

With the following example, if user want to access the 2nd bit of the input address 1. The users have to use the [01-read coil] command to read the address = $1*8*2+2+1 = 19$. If users want to access the 4 bytes input data with Modbus register access command, the users have to use the [03-read holding register] command to read the address = $8/2+1 = 5$ with length 2.

System Settings

This configuration tab includes several system level settings such as security, alarm and information log. Most of these settings are optional.

Accessible IP Settings

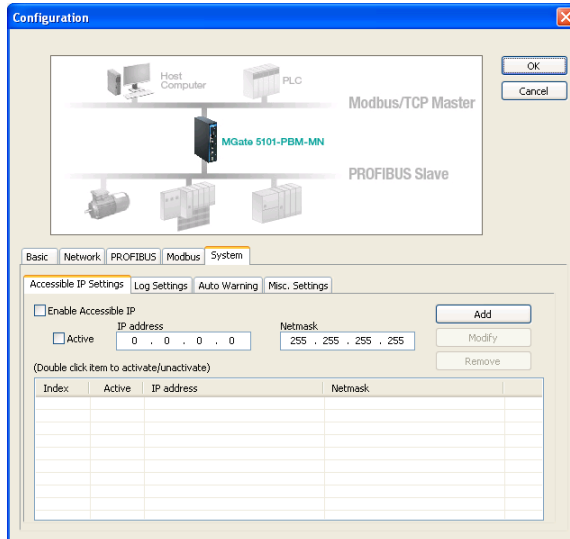

This settings is used this restrict access to the module by IP address. Only IP addresses on the list will be allowed access to the module. You may add a specific address or range of addresses by using a combination of IP address and netmask, as follows:

To allow access to a specific IP address

Enter the IP address in the corresponding field; enter 255.255.255.255 for the netmask.

To allow access to hosts on a specific subnet

For both the IP address and netmask, use 0 for the last digit (e.g., "192.168.1.0" and "255.255.255.0").

To allow access to all IP addresses

Make sure that Enable the accessible IP list is not checked.

Additional configuration examples are shown in the following table:

Desired IP Range	IP Address Field	Netmask Field
Any host	Disable	Enable
192.168.1.120	192.168.1.120	255.255.255.255
192.168.1.1 to 192.168.1.254	192.168.1.0	255.255.255.0
192.168.1.1 to 192.168.255.254	192.168.0.0	255.255.0.0
192.168.1.1 to 192.168.1.126	192.168.1.0	255.255.255.128
192.168.1.129 to 192.168.1.254	192.168.1.128	255.255.255.128

Log Settings

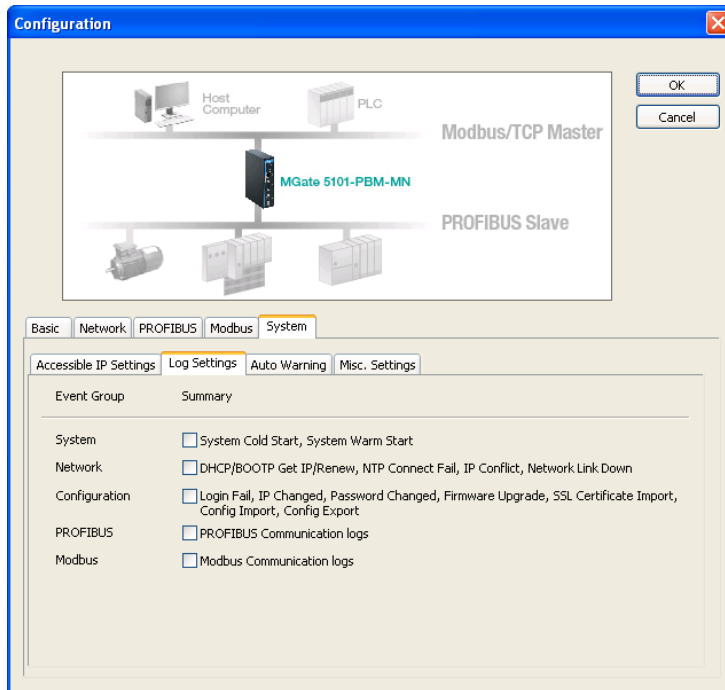

This setting will enable the MGate firmware to record the important event for future verification. The record information can only be displayed in web console. Please refer to chapter 5.

The available information which can be record includes the following events:

Parameters	Event
System	System Cold Start, System Warm Start.
Network	DHCP/BOOTP Get IP/Renew, NTP Connect Fail, IP Conflict, Network Link Down.
Configuration	Login Fail, IP Changed, Password Changed, Firmware Upgrad, SSL Certificate Import, Configuration Import/Export.
PROFIBUS	PROFIBUS Communication logs.
Modbus	Modbus Communication logs.

Users can view the record from the web console or text mode console.

System Log

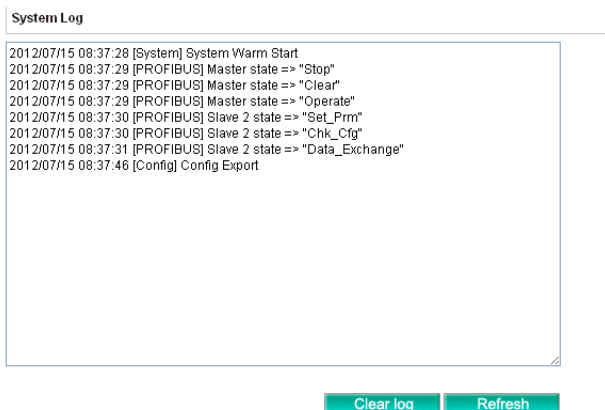

Auto Warning (Relay Output)

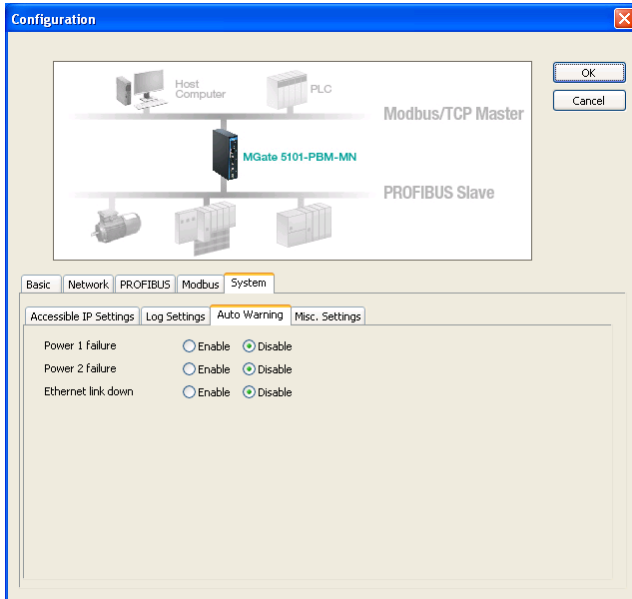

Auto Warning will be triggered in the event of a power failure or when Ethernet links are disconnected. When a checked trigger condition occurs, the MGate will open the circuit of the relay output and trigger the Fault LED to start blinking. Otherwise, the MGate will short circuit the relay output.

Misc. Settings

This tab includes console settings, password and relay output.

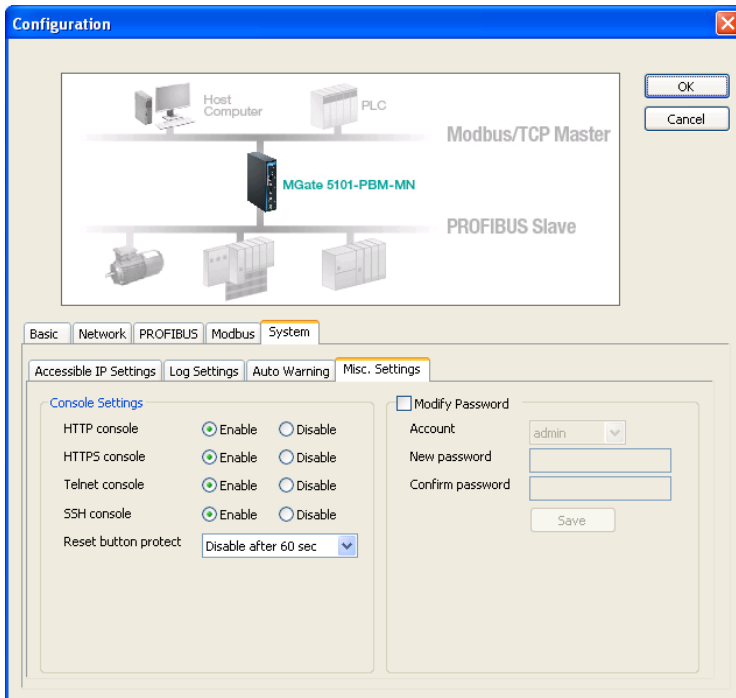

Console Settings

Parameters	Value	Description
HTTP/HTTPS	Enable/Disable	This setting is to enable/disable the web console. For security issue, users can only enable the HTTPS or just disable all settings. But users only can access the configuration from telnet/ssh or utility.
Telnet/SSH	Enable/Disable	This setting is to enable/disable the text mode console. For security issue, users can only enable the SSH or just disable all settings. But users only can access the configuration from HTTP/HTTPS or utility.
Reset button protect	Disable after 60 sec, Always enable	MGate provide the reset button to load factory default settings. But for security issue, users can disable this function. In disabled mode, MGate will still enable this function within 60 seconds after boot-up just in case users really need to reset function.

Modify Password

Parameters	Value	Description
Account	admin, user	Users can modify the password for different account. Now MGate provide two different level accounts. One is "admin". The account "admin" can access and modify all the settings through console. Another one is "user". This account only can view the setting and can't change anything.

Load Default

If for some reason you would like to clear all the settings of the unit, the **Load Default** button can help users to reset the unit to its initial factory default values.

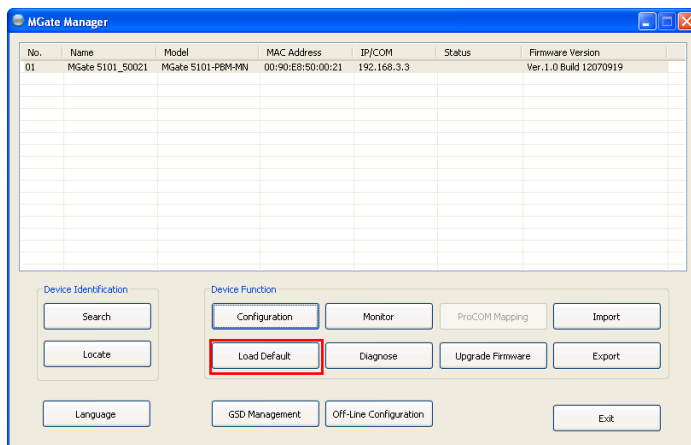

Click Load Default and review the confirmation message. If you are sure you would like to reset the configuration to the factory default, click the **OK** button. If not, click **Cancel**.

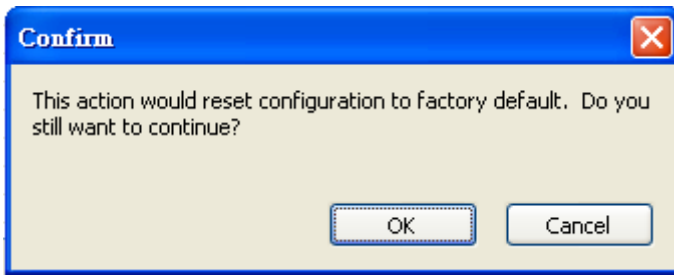

After the MGate Manager resets completely, MGate Manager will automatically execute a Broadcast Search for all MGate units on the LAN. Your MGate should reappear in the list of units.



ATTENTION

Load Default will completely reset the configuration of the unit, and all of the parameters you have saved will be discarded. Do not use this function unless you are sure you want to completely reset your unit.

Monitoring Modbus Activity

For troubleshooting or management purposes, you can monitor the data passing through any MGate 5101-PBM-MN on the Modbus side. Data events will be logged as they pass through the gateway. Rather than simply echoing the data, MGate Manager presents the data in an intelligent, easily-understood format, with clearly designated fields including source, type, destination, contents, and more. Events can be filtered in different ways (Exception, Slave ID, Source, Function Code), and the complete log can be saved to a file for later analysis.

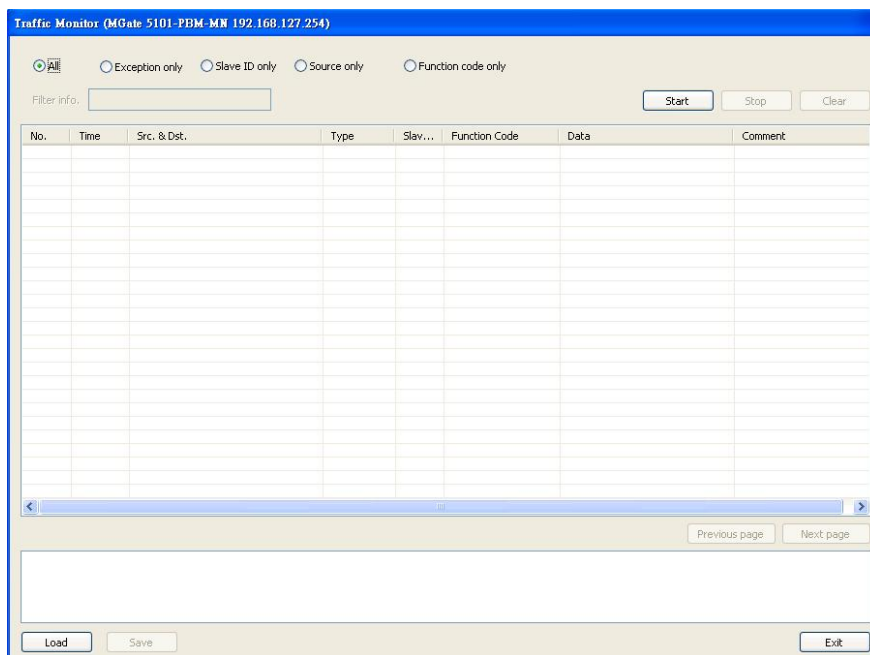

Open Traffic Monitor Window

Select the unit that you wish to monitor and click **Monitor** to open the Traffic Monitor window.

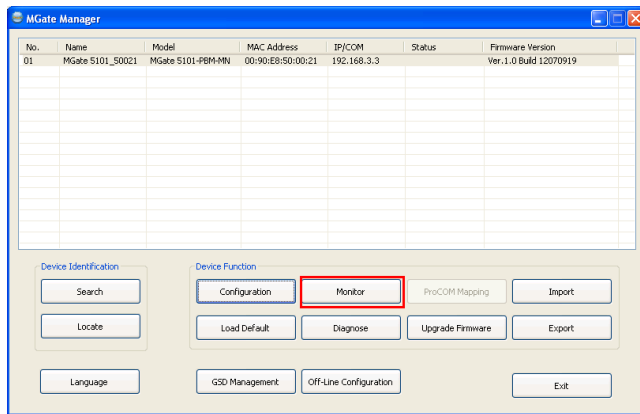

In the Traffic Monitor window, click **Start** to begin live monitoring of the data passing through the selected MGate 5101-PBM-MN unit.

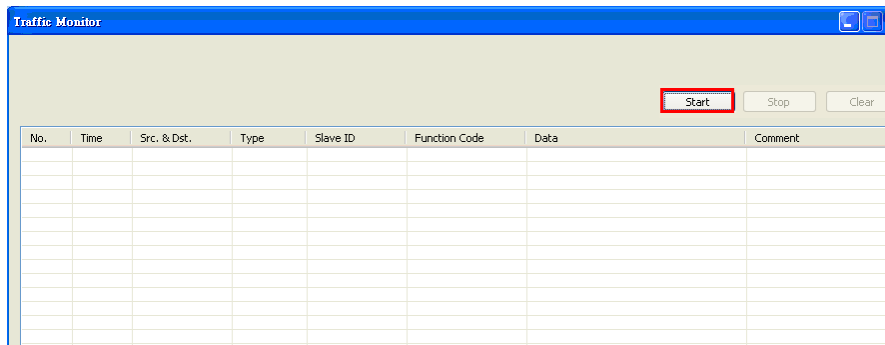

To stop capturing the log, press the **Stop** button.

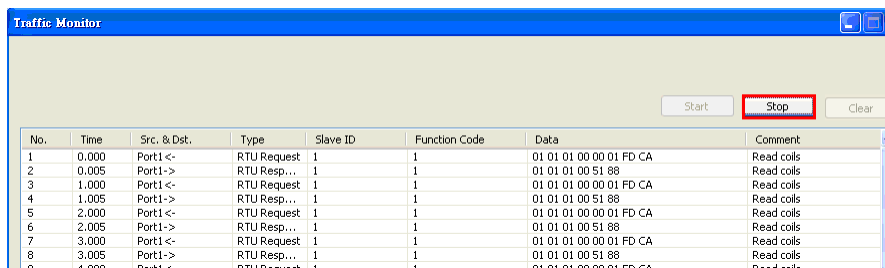

Save Log to File

To save the data log to a file, click **Save**. You may retrieve a saved log by clicking **Load**.

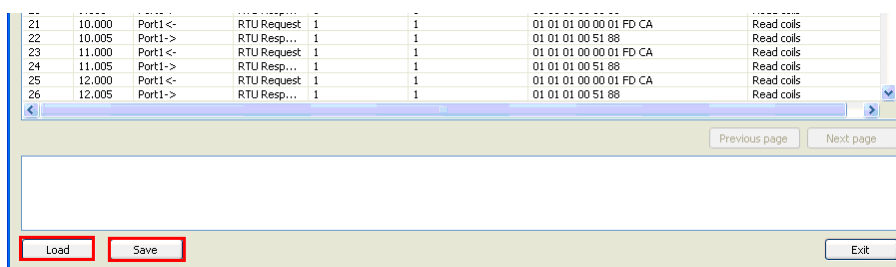

Diagnose

MGate also provides the statics information for troubleshooting, especially for PROFIBUS slave devices. In most applications, MGate will connect several PROFIBUS slaves at the same time. If some devices can't work well, it is hard for users to know which one has the communication issue. With this function, you can identify the issue immediately and solve the issue. To open the diagnose window, click the Diagnose button in main window.

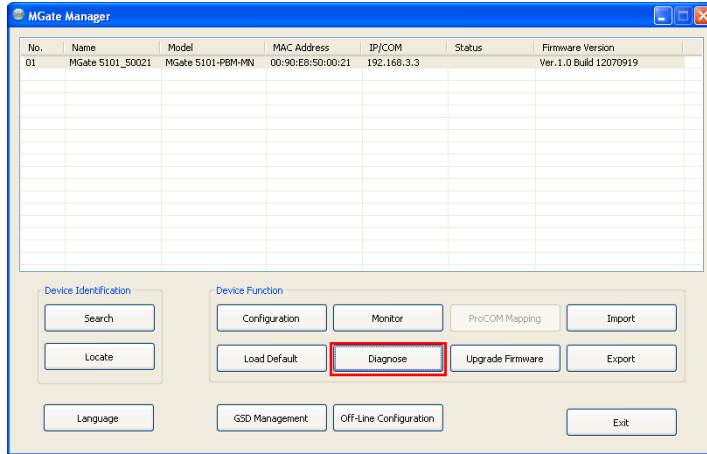

The diagnose windows will be displayed. It includes the Modbus and PROFIBUS information.

For Modbus, it will display different information for master and slave settings.

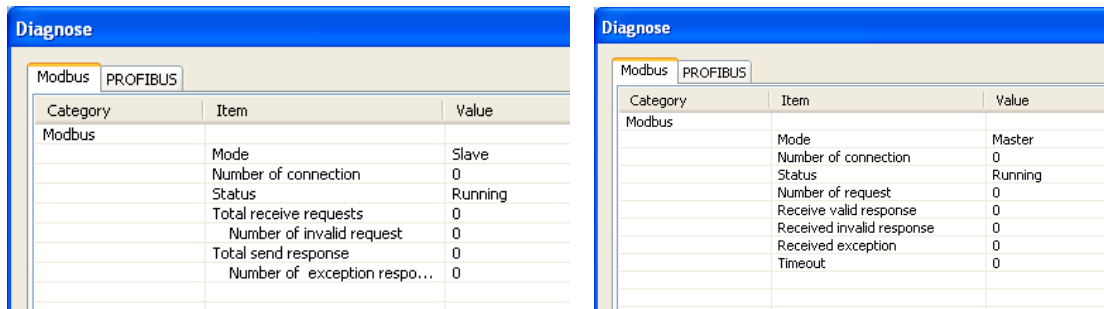

For PROFIBUS, it will display all configured devices. Users can double click the slave device, and it will display the detail information for selected device.

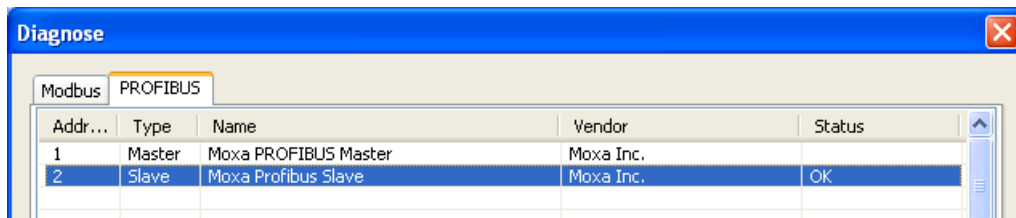

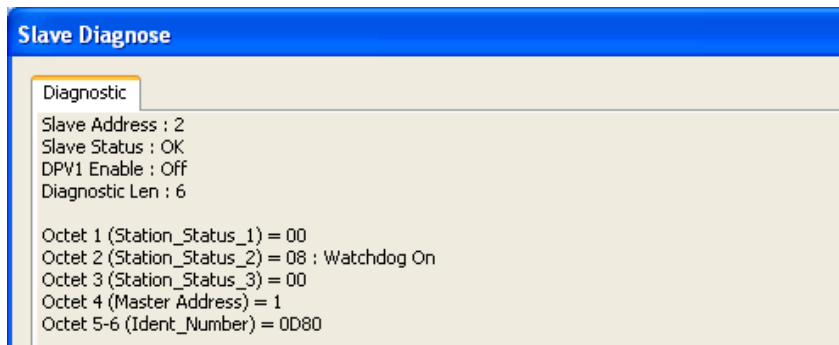

This information displays the PROFIBUS DP diag_data information.

Octet 1 (Station_status_1):

Bit	Value	Description
Bit 7	Diag.Master_Lock	This bit is set if the slave is parameterized by other master.
Bit 6	Diag.Prm_Fault	This bit is set if master last request is invalid.
Bit 5	Diag.Invalid_Slave_Response	This bit is set if master receive an invalid slave response.
Bit 4	Diag.Not_Supported	This bit is set if last master request is not supported by slave.
Bit 3	Diag.Ext_Diag	This bit is set if the diag_data contains the vendor defined message.
Bit 2	Diag.Cfg_Fault	This bit is set if the slave configuration is different from the master.
Bit 1	Diag.Station_Not_Ready	This bit is set if the slave is not ready for data exchange.
Bit 0	Diag.Station_Non_Existent	This bit is set if the slave can't be reached.

Octet 2 (Station_status_2):

Bit	Value	Description
Bit 7	Diag.Deactivated	This bit is set if the slave is marked as inactive within parameter set.
Bit 6	Reserved	
Bit 5	Diag.Sync_Mode	This bit is set if the slave receive the sync control command.
Bit 4	Diag.Freeze_Mode	This bit is set if the slave receive the freeze control command.
Bit 3	Diag.WD_On (Watchdog on)	This bit is set if the watch dog control is activated by slave.
Bit 2	N/A	(Not used)
Bit 1	Diag.Stat_Diag	This bit is set if the slave request master to send the diag_data request.
Bit 0	Diag.Prm_Req	This bit is set if the slave request re-parameterized.

Octet 3 (Station_status_3):

Bit	Value	Description
Bit 7	Diag.Ext_Diag_Overflow	This bit is set if the more diag information is provided in Ext_diag_data.
Bit 0 to 6	Reserved	

Octet 4 (Station_status_4):

Bit	Value	Description
Bit 0 to 7	Diag.Master_Add	The master PROFIBUS address..

Octet 5~6: Ident_number, the manufacture identifier number of the slave device. This also can be listed in GSD file.

Octet 7~32: Exg_Diag_data, this is diagnose data specified by slave device.

Create/Modify the Configuration File

Users can create or modify the configuration file manually through MGate Manager. The configuration file can be generated by "Export" function. The file generated by this function also can be used in "Import" function.

To use this function, user can click the "Off-Line Configuration" button to load the configuration window.

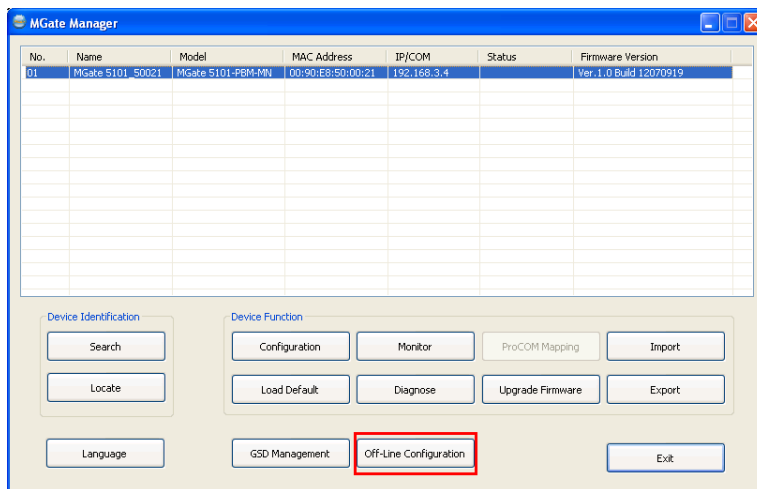

A dialog will be displayed. Please click "OK" button to go next step.

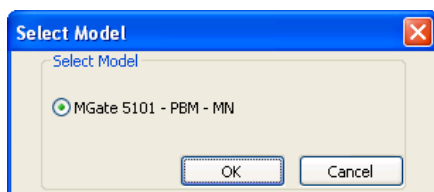

Users can choose "Create new configuration" or "Load exist configuration" to edit the configuration. For "Load exist configuration", the file can be generated from Export function.

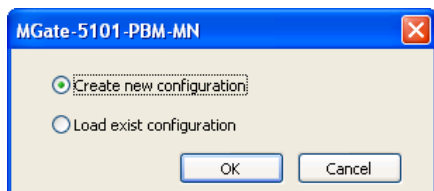

For the configuration dialog, users can refer to "Modifying the Configuration" section for detail information. When all items configuration are finished, click ok to update the setting into the file.

Upgrading Firmware

Firmware updates for the MGate 5101-PBM-MN are located at www.moxa.com. After you have downloaded the new firmware onto your PC, you can use MGate Manager to write it onto your MGate 5101-PBM-MN. Select the desired unit from the list in MGate Manager and click **Upgrade Firmware** to begin the process.

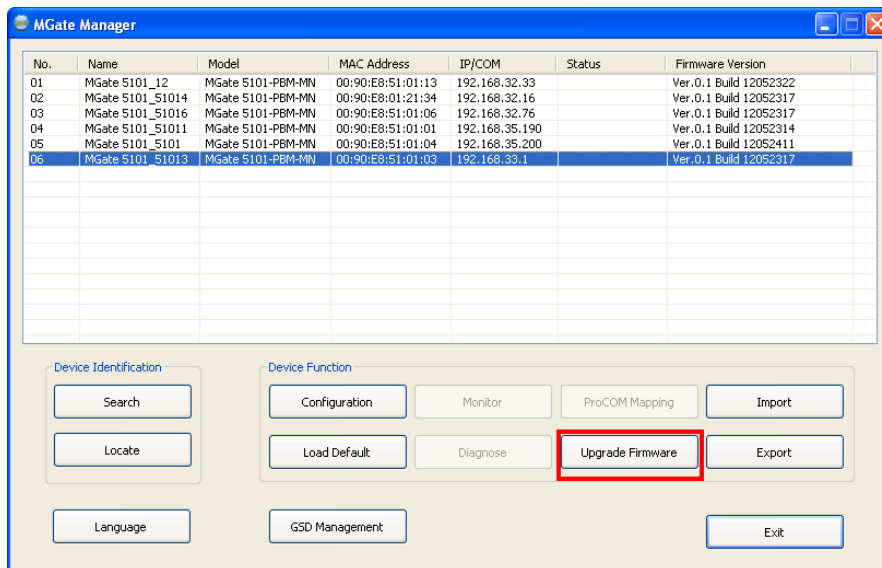

The dialog boxes will guide you through the process. You will need to browse your PC for the firmware file. Make sure that it matches your model.

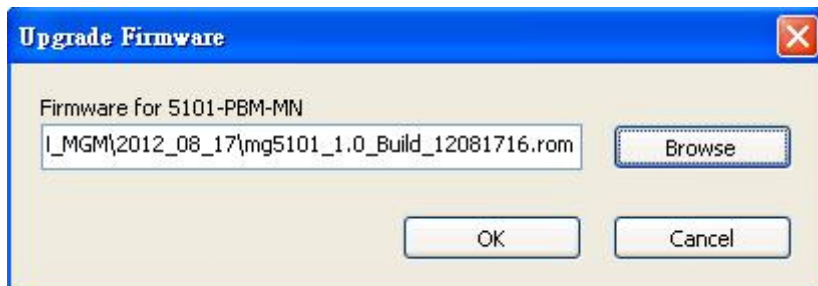

As the firmware is written to the unit, progress is displayed in the window.

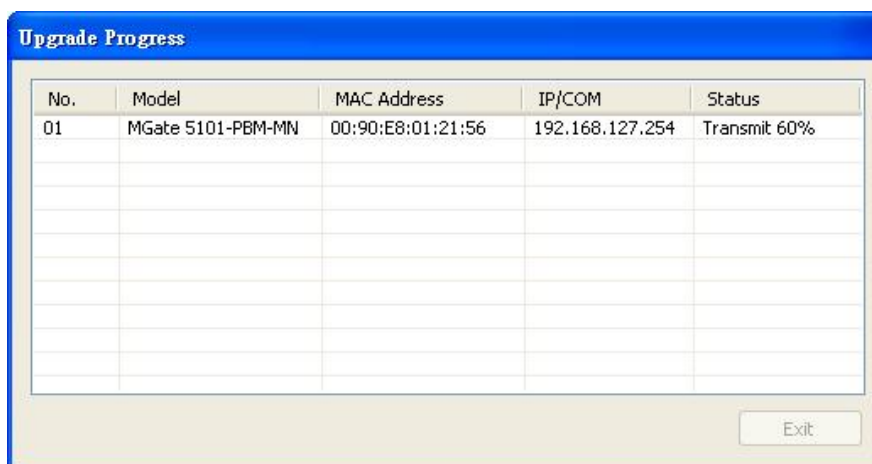

Once the firmware has been successfully written onto the unit, click **Exit** to close the Upgrade Firmware window. MGate Manager will automatically execute a Broadcast Search for all MGate units on the LAN. Your MGate should reappear in the list of units.

Import/Export

The Import/Export configuration function is a convenient way to apply the same settings to units which are located in different sites. You can export the configuration as a file, and then import that configuration file onto other units at any time.

The export function saves all the configuration settings and parameters of the MGate 5101-PBM-MN will be saved in an .ini file. To begin, click the **Export** button.

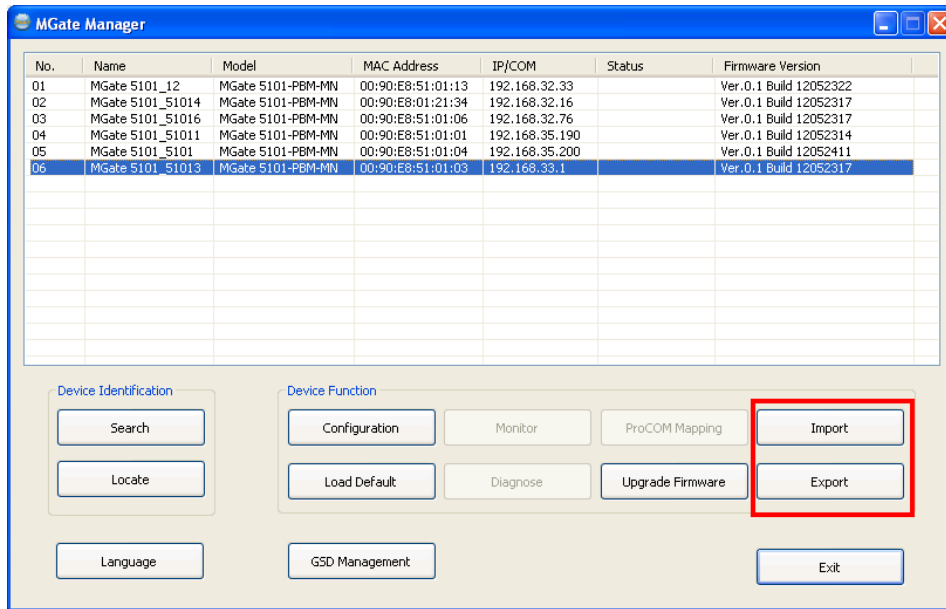

Type in a file name and use the **Browse** button to set the save file to a specific path. Then, click the **OK** button.

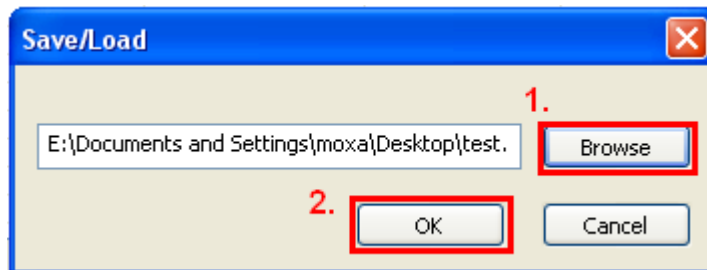

If you export the configuration file successfully, a confirmation message will pop up.



After that, the configuration file will be saved as an .ini file

Once the file is saved, it can be imported into your target unit to duplicate the same settings. Select the target unit first and click the **Import** button to import.

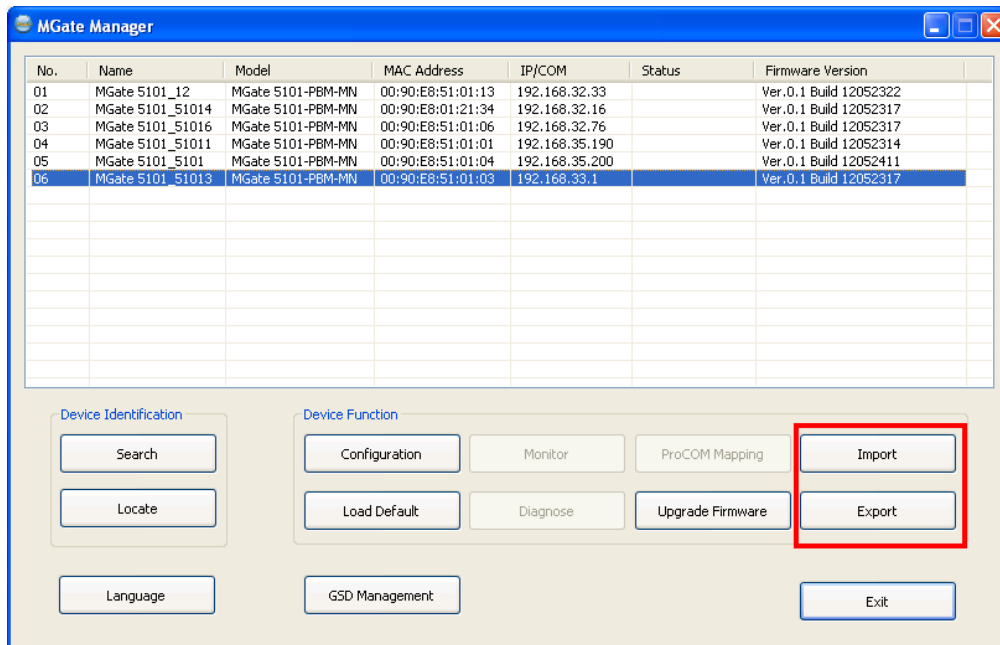

Select the file you want to import, then click the **OK** button

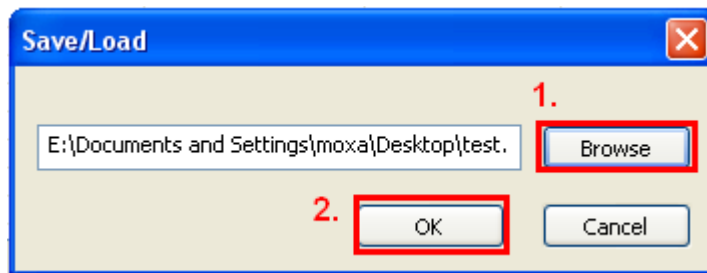

Please be patient and wait as MGate Manager configures the target device.

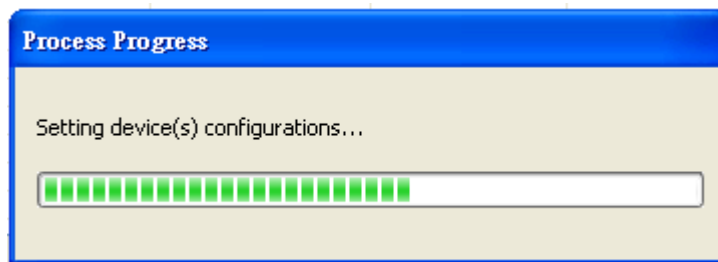

If you import the configuration file successfully, a confirmation message will pop up.



After closing the message dialog, MGate Manager will automatically execute a Broadcast Search for all MGate units on the LAN. Your MGate should reappear in the list of units.

Configuration (Web Console)

MGate 5101-PBM-MN also provides the web console for configuration, but only for limited items. For example, the PRFOFIBUS and Modbus TCP settings are not included in web console and only available in MGate Manager. Users can use the browser such as Microsoft Internet Explorer or Google chrome to access web console.

To connect to MGate web console, please load the browser and input the MGate IP address.

http://<MGate IP address>

or

https://<MGate IP address>

At the first page, users need to specify the account and password. The account now only support two types of users: one is admin and another one is user. "admin" account can modify all the settings, but "user" account only can review the settings. The configuration modification is not allowed for "user" account.

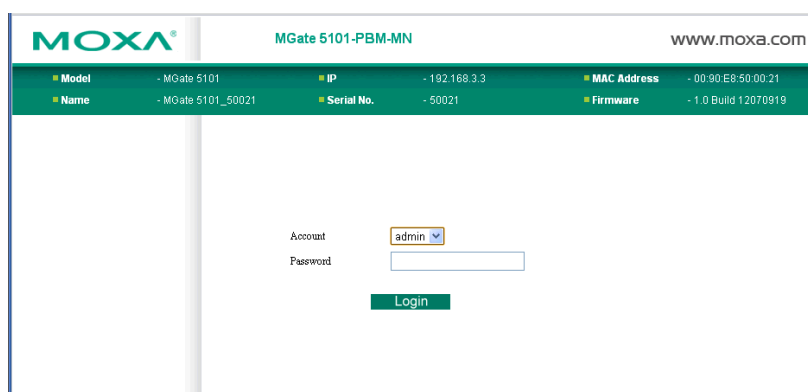

All available configuration items are listed on left panel tree. Users can click the item to see detail options on right panel area. To active the change, users need to click the "Submit" button before leaving the current page. If necessary, MGate will need to restart to activate the setting.

The following functions are the same MGate Manager utility. Please refer to the relative sections.

Function	Note
Basic Settings	Please refer to Configure Device section.
Network Settings	Please refer to Network Settings section.
System Management – Accessible IP List	Please refer to Accessible IP Settings section.
System Management – System Log Settings	Please refer to Log Settings section.
System Management – Auto Warning Settings	Please refer to Auto Warning section.
System Management – Misc. Settings - Console Settings	Please refer to Console Settings section.
System Management – Misc. Settings - Change Password	Please refer to Modify Password section.
System Management – Maintenance - Firmware Upgrade	Please refer to Upgrading Firmware section.
System Management –Maintenance - Configuration Import	Please refer to Import/Export section.
Function	Note

System Management –Maintenance - Configuration Export	Please refer to Import/Export section.
System Management –Maintenance - Load Factory Default	Please refer to Load Default section.

PROFIBUS Control (System Management – Maintenance - PROFIBUS Control)

Users can configure the PROFIBUS interface of MGate to different operation mode. The available options are “Operate”, “Clear” and “Stop”. Users can click “Activate” to change the mode immediately. The PBM LED will also show the different the status for this change. Please refer to **LED Indicators** section.

This function is only available on web console and text mode console.

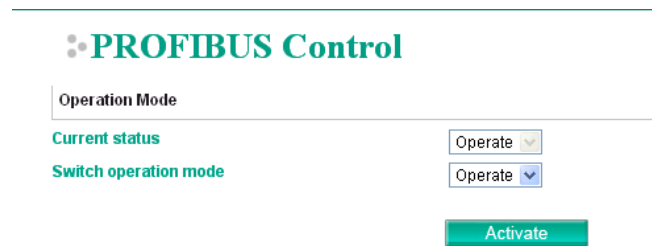

Operation mode for PROFIBUS

Mode	Descriptions
STOP	The parameters are loaded, but the data_exchange is not running.
CLEAR	The data_exchange is running, but the input data will be ignored and only the output data will be transferred.
OPERATE	All PROFIBUS data_exchagne between master and slaves works well.

Ping (System Management – Maintenance – Ping)

This function is for network testing. MGate will send the ICMP packet through network to specified host. Users can see the result at the web console immediately. This function is only available on web console and text mode console.

Certificate (System Management – Certificate)

This is where you can load the Ethernet SSL certificate. Select or browse for the certificate file in the Select SSL certificate/key file field. This function is only available on web console and serial console. (Telnet/SSH console doesn't support this function)

I/O Data View

This page can display the internal memory information for input and output data transfer. It can display the updated value for communication verification. This function is only available on web console and text mode console.

I/O Data View

Auto refresh

I/O: Start Address(Hex): Len: Format:

Internal Address	00	01	02	03	04	05	06	07	08	09	0A	0B	0C
0000h	00	00	00	00	00	00	00	00	00	00	00	00	00
0010h	00	00	00	00	00	00	00	00	00	00	00	00	00
0020h	00	00	00	00	00	00	00	00	00	00	00	00	00
0030h	00	00	00	00	00	00	00	00	00	00	00	00	00
0040h	00	00	00	00	00	00	00	00	00	00	00	00	00
0050h	00	00	00	00	00	00	00	00	00	00	00	00	00
0060h	00	00	00	00	00	00	00	00	00	00	00	00	00
0070h	00	00	00	00	00	00	00	00	00	00	00	00	00

PROFIBUS Live List

This page will display the available PROFIBUS device on network. This function is the similar to the MGate Manager Diagnose function, but it can't display the detail information. If the device is disconnected, it will not be displayed in the list even though it is configured in PROFIBUS network. This behavior is different from the MGate Manager Diagnose function. This function is only available on web console and text mode console.

PROFIBUS Live List

Address	Type	Name	Associated Master Addr.	Ident.No.	Input Bytes	Output Bytes	Status
1	Master	Moxa PROFIBUS Master	-	0x0DF3	0	0	
2	Slave	Moxa Profibus Slave	1	0x0D80	192	192	OK

Configuration (Text Mode Console)

MGate 5101-PBM-MN provides the text mode console with serial interface, telnet and SSH protocol. The user interface is the same in all text mode consoles. Please note the text mode console doesn't provide all configuration items. For example, the PRFOFIBUS and Modbus TCP settings are not included in text mode console and only available in MGate Manager.

For telnet and SSH, users can use HyperTerminal or PuTTY program to connect to MGate. Please note the telnet protocol will transfer the account and password information in the internet with plain text, so now it is almost obsolete and replaced by SSH protocol.

To connect to MGate telnet/SSH console, please load telnet/SSH program and connect to the MGate IP address.

For serial interface, users need to use the serial port in the host to connect to MGate serial console port in front of panel with null modem (crossover) cable. The serial console parameter is 115.2kbps, none parity, 8 data bits and one stop bit. Users can use terminal program such as PComm Terminal Emulator or PuTTY to connect to MGate serial console.

At the first page, users need to specify the account and password. The account now only support two types of users: one is admin and another one is user. "admin" account can modify all the settings, but "user" account only can review the settings. The configuration modification is not allowed for "user" account.

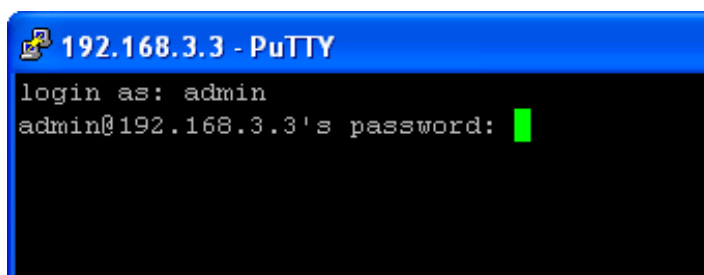

```
192.168.3.3 - PuTTY
login as: admin
admin@192.168.3.3's password: █
```

The text mode console will display the menu driven interface. Users can use arrow key to move the menu bar. To select the option, please press the "Enter" key to go next level menu. To go previous level menu, please press "Esc" key to quit. If necessary, MGate will need to restart to activate the setting.

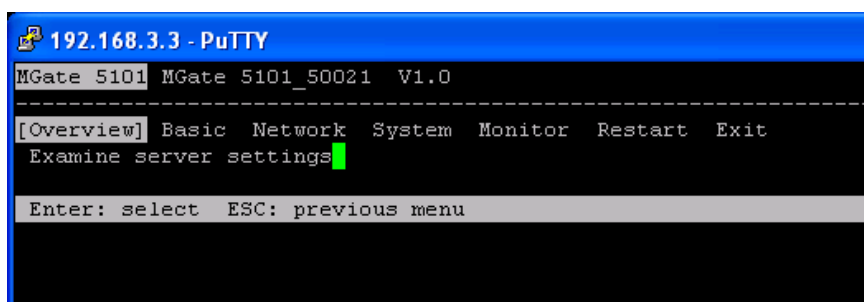

```
192.168.3.3 - PuTTY
MGate 5101 MGate 5101_50021 V1.0
-----
[Overview] Basic Network System Monitor Restart Exit
Examine server settings █
Enter: select ESC: previous menu
```

The following functions are the same as MGate Manager utility and web console. Please refer to the relative sections.

Function	Note
Basic	Please refer to Configure Device section.
Network	Please refer to Network Settings section.
System - Accessible_ip	Please refer to Accessible IP Settings section.
System - Sys_log	Please refer to Log Settings section.
System - auto_warning	Please refer to Auto Warning section.
System - Misc. - Console	Please refer to Console Settings section.
System - Misc. - password	Please refer to Modify Password section.
System - maintenance - profibus_ctrl	Please refer to PROFIBUS Control section.
System - maintenance - Ping	Please refer to Ping section.
System - maintenance - Upgrade	Please refer to Upgrading Firmware section
System - maintenance - Import/Export	Please refer to Import/Export section.
System - maintenance - Default	Please refer to Load Default section.
System - Certificate	Please refer to Certificate section.
Monitor - System - sys_log	Please refer to Log Settings section.
Monitor - System - relay_state	Please refer to Auto Warning section.
Monitor - Live_list	Please refer to PROFIBUS Live List section.
System - I/O data view	Please refer to I/O Data View section.