

HOBO® MX Soil Moisture (MX2306) and MX Soil Moisture and Temperature (MX2307) Data Logger Manual



MX2307 Model Shown

The HOBO MX Soil Moisture (MX2306) and HOBO MX Soil Moisture and Temperature (MX2307) data loggers measure soil moisture and temperature in numerous soil types, including high salinity and sandy soil. These Bluetooth®-enabled loggers are designed for wireless communication with a phone, tablet, or computer. Using the HOBObconnect® app, you can easily configure the logger and then download logged data to view or export for further analysis. The logger can calculate minimum, maximum, average, and standard deviation statistics and be configured to indicate alarms at user-specified thresholds. The loggers also support burst logging, in which data is logged at a faster interval when sensor readings are above or below certain limits.

HOBO MX2306 and MX2307 Data Loggers

Models:

- Soil Moisture (MX2306)
- Soil Moisture and Temperature (MX2307)

Included Items:

- Screws
- Cable ties

Required Items:



- HOBObconnect app
- Mobile device with Bluetooth and iOS, iPadOS®, or Android™, or a Windows computer with a native BLE adapter or supported BLE dongle

Accessories (sold separately):

- Solar radiation shield (RS3-B for use with MX2307)
- Soil moisture verification clip (TEROS-CLIP)
- Replacement battery (HRB-2/3AA)

Specifications

Measurement Range (select one at configuration)	0.00 to 0.64 m ³ /m ³ VWC in mineral soils 0.00 to 0.70 m ³ /m ³ VWC in soilless media Apparent Dielectric Permittivity: 1 (air) to 80 (water)
Accuracy *	±0.031 m ³ /m ³ typical in mineral soils that have solution EC <8 dS/m ±0.051 m ³ /m ³ typical in soilless media Apparent Dielectric Permittivity: +/- 1 E _a for the range 1 to 40 (soil range); +/-15% for over 40
Resolution	0.001 m ³ /m ³ Apparent Dielectric Permittivity: 0.1 E _a
Dielectric Measurement Frequency	70 MHz
Volume of Influence	430 ml
Percent of Field Capacity (for VWC measurements only)	Range: 0 to 200% Resolution: 0.1%
Temperature Sensor (MX2307)	
Range	-40 to 100°C (-40 to 212°F), with tip and cable immersion in fresh water up to 50°C (122°F) for one year
Accuracy	±0.25°C from -40 to 0°C (±0.45 from -40 to 32°F) ±0.2°C from 0 to 70°C (±0.36 from 32 to 158°F) ±0.25°C from 70 to 100°C (±0.45 from 158 to 212°F)
Resolution	0.04°C (0.072°F)
Drift	<0.01°C (0.018°F) per year
Response Time	3 minutes in air moving 1 m/s; 20 seconds in stirred water 4 minutes in air moving 1 m/s with RS3-B Solar Radiation Shield
Logger	
Operating Range	-25° to 60°C (-13° to 140°F)
Radio Power	1 mW (0 dBm)
Transmission Range	Approximately 30.5 m (100 ft) line-of-sight
Wireless Data Standard	Bluetooth Low Energy (Bluetooth Smart)
Logging Rate	1 second to 18 hours
Logging Modes	Fixed Interval Logging or Burst Logging
Memory Modes	Never Stop (Overwrites Old Data) or Stop When Full
Start Modes	On Save (immediate), On Next Interval, On Push Button, On Date/Time
Stop Modes	Never Stop (Overwrites Old Data), On Date/Time, After (a specified amount of time), Stop When Memory Fills

Time Accuracy	±1 minute per month 0° to 50°C (32° to 122°F)
Battery Type	2/3 AA 3.6 Volt lithium, user replaceable
Battery Life	2 years, typical with logging interval of 1 minute and Bluetooth Always On enabled; 5 years, typical with logging interval of 1 minute and Bluetooth Always On disabled. Faster logging intervals and statistics sampling intervals, burst logging, remaining connected with the app, excessive downloads, and paging may impact battery life.
Memory	110,000 measurements, maximum (472 KB)
Full Memory Download Time	Approximately 60 seconds; may take longer the further the device is from the logger
Dimensions	Logger housing: 10.8 x 5.08 x 2.24 cm (4.25 x 2.0 x 0.88 in.) Soil moisture sensor: 7.5 x 5.1 x 2.4 cm (2.95 x 2.02 x 0.95 inches) Soil moisture sensor needle length: 5.4 cm (2.13 inches) Soil moisture sensor needle diameter: 0.32 cm (0.13 inches) Temperature sensor (MX2307) diameter: 0.53 cm (0.21 in.) Sensor cable length: 2 m (6.56 ft)
Weight	MX2306: 229 g (80 oz) MX2307: 267 g (94 oz)
Materials	Logger: Acetal, silicone gasket, stainless-steel screws Soil Moisture Sensor: ASA plastic body with polyurethane epoxy filling and stainless-steel pins Temperature Sensor (MX2307): Stainless-steel waterproof tip Cable: PVC, UV resistant and rodent repellent (soil moisture sensor cable)
Environmental Rating	Logger: -25 to 60°C (-13 to 140°F); weatherproof; NEMA 6 and IP67 Soil Moisture sensor and cable: -40 to 60°C (-40 to 140°F) Temperature sensor and cable (MX2307): Immersion in water up to 50°C (122°F) for 1 year
	The CE Marking identifies this product as complying with all relevant directives in the European Union (EU).
	The UKCA marking identifies this product as complying with all relevant directives in the UK Declaration of Conformity.
	See last page.

*For additional accuracy, the sensor data can be post-calibrated for a particular soil by applying a calibration equation to the data exported from the app.

Logger Components and Operation



MX2307 model shown

Mounting Holes: Use the holes at the top and bottom of the logger to mount it (see *Deploying and Mounting the Logger*).

Alarm LED: This LED blinks red every 4 seconds when an alarm is tripped (unless Show LED is disabled as described in *Configuring the Logger*).

Status LED: This LED blinks blue every 4 seconds when the logger is logging (unless Show LED is disabled as described in *Configuring the Logger*). If the logger is waiting to start logging because it was configured to start On Button Push or with a delayed start, it blinks every 8 seconds.

Start Button: Press this button to wake up the logger; both the alarm and status LEDs blink. Once the logger is awake, press this button to move it to the top of the devices list in the app. Press this button for 3 seconds to start or stop the logger when it is configured to start or stop On Button Push (see *Configuring the Logger*). Both LEDs blink four times when you press the button to start or stop logging. Press this button for 10 seconds to reset a password (see *Setting a Password*).

External Sensor: This is the soil moisture (and temperature sensor in MX2307 model) attached to the bottom of the logger.

Soil Moisture Sensor Components and Operation

The soil moisture sensor measures the volumetric water content (VWC) of soil using stainless-steel needles. A ferrite core positioned on the sensor cable 7.6 cm (3 inches) away from the sensor head is used to isolate the sensor from any interferences in the system. This mitigates any potential noise from the system on the measured sensor data.

Important: Do not attach anything to the section of the cable between the sensor head and the ferrite core as this may influence the measurements.

WARNING: Risk of personal injury is present. Sensor needle points are extremely sharp and will puncture skin. Handle with care.

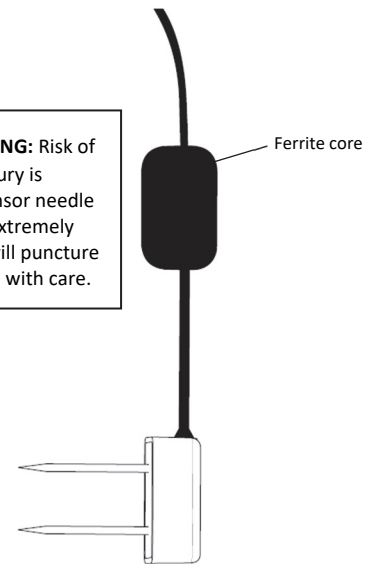

The VWC measurement sensitivity is contained within a 430 mL volume roughly depicted in the following figures. Note that the sensor is most sensitive to the moisture in the area closest to the needles, so it is critical that there are no air gaps around the needles.

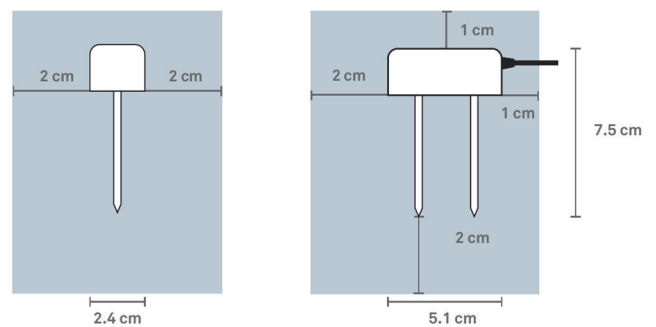
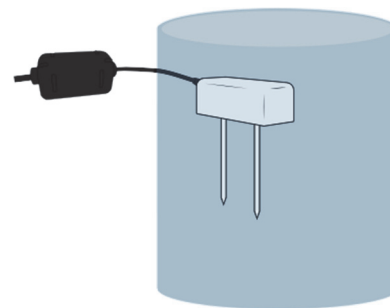

Downloading the App and Connecting to a Logger

Install the app to connect to and work with the logger.









1. Download HOBObconnect to a phone or tablet from the App Store® or Google Play™.
Download the app to a Windows computer from www.onsetcomp.com/products/software/hobobconnect.
2. Open the app and enable Bluetooth in the device settings if prompted.

3. Press the button on the logger to wake it up.
4. Tap Devices and then tap the logger tile in the app to connect to the logger.

If the logger does not appear or if it is having trouble connecting, follow these tips:

- Make sure the logger is awake by pressing the start button. The alarm and status LEDs blink once when the logger wakes up. You can also press the button a second time to bring the logger to the top of the list if you are working with multiple loggers.
- Make sure the logger is within range of the mobile device or computer. The range for successful wireless communication is approximately 30.5 m (100 ft) with full line-of-sight.
- If there are several loggers in the area, move the logger to a location with fewer loggers. Interference sometimes occurs when numerous loggers are in one location.
- If your device can connect to the logger intermittently or loses its connection, move closer to the logger, within sight if possible.
- If the logger appears in the app, but cannot be connected, close the app and then power down the device to force the previous Bluetooth connection to close.

Once the logger is connected, you can:

Tap this:	To do this:
	Specify logger settings and save them onto the logger to start logging. See <i>Configuring the Logger</i> .
	Tap to view live data.
	Mark the logger as a favorite. You can then filter the list of devices to show only loggers marked as favorites.
	Illuminate the logger LEDs for 4 seconds.
	Start logging if the logger was configured to start with a button push. See <i>Configuring the Logger</i> .
	Stop logging data (this overrides any Stop Logging settings described in <i>Configuring the Logger</i>).
	Download logger data. See <i>Downloading Data From the Logger</i> .
	Lock the logger. Set a password for the logger so that it is not mistakenly stopped or reconfigured. Tap the icon, enter a password, and then tap Set. Once a password is entered on a phone or tablet, that mobile device is the only one to “remember” it. This means you can connect to the logger without entering a password on that

mobile device, but you must enter a password on all other mobile devices. For example, if you set the password for the logger with your tablet and then try to connect to the device later with your phone, you must enter the password on the phone but not with your tablet. Similarly, if others attempt to connect to the logger with different devices, they are also required to enter the password.

To reset a password:

- Simultaneously press both the Start/Stop button and the Alarm/Stats button for 3 seconds, or
- Tap Manage Password and then tap Reset.



Manage Password. Reset your existing password or set a new password for the logger.



Update the firmware on the logger. A logger readout will be completed automatically at the beginning of the firmware update process

Important: Before updating the firmware on the logger, check the remaining battery level and make sure it is no less than 30%. Make sure you have the time to complete the entire update process, which requires that the logger remains connected to the device during the upgrade.

Configuring the Logger

Use the app to set up the logger, including setting alarms, selecting the options to start and stop logging, and choosing a logging mode. These steps provide an overview of setting up the logger. For complete details, see the HOBOnnect User Guide.

1. In the app, tap Devices and then tap the logger tile to connect to the logger.
2. Tap Configure & Start to configure the logger.
3. Tap Name and type a name for the logger. If you do not enter a name, the app uses logger serial number as the name.
4. Tap Group to add the logger to a group (optional).
5. Tap Logging Interval and choose how frequently you want the logger to record data unless operating in burst logging mode (see *Burst Logging*). **Note:** If an alarm is configured, the logger uses the logging interval as the rate to check for alarm conditions (alarms are not available if Burst Logging is selected). See *Setting up Alarms* for more details.
6. Tap Start Logging and select when logging begins:
 - **On Save.** Logging begins immediately after configuration settings are saved.
 - **On Next Interval.** Logging begins at the next even interval as determined by the selected logging interval.
 - **On Button Push.** Logging begins when you press either the Start/Stop logging button on the logger for 3 seconds or start logging with the app.
 - **On Date/Time.** Logging begins at a date and time you specify. Select the Date and Time.

7. Tap Stop Logging and specify when logging ends:
 - **Never Stop (Overwrites Old Data).** The logger does not stop at any predetermined time. The logger continues recording data indefinitely, with newest data overwriting the oldest.
 - **On Date/Time.** The logger stops logging on a specific date and time that you specify.
 - **After.** Select this if you want to control how long the logger should continue logging once it starts. Choose the amount of time you want the logger to log data. For example, select 30 days if you want the logger to log data for 30 days after logging begins.
 - **Stop When Memory Fills.** The logger continues recording data until the memory is full.
8. Tap Pause Options, then select Pause On Button Push to specify that you can pause the logger by pressing its Start/Stop button for 3 seconds.
9. Tap Logging Mode. Select either Fixed Logging Mode or Burst Logging. With fixed logging, the logger records data for all enabled sensors and/or selected statistics at the logging interval selected (see *Statistics Logging* for details on choosing statistics options). In burst mode, logging occurs at a different interval when a specified condition is met. See *Burst Logging* for more information.
10. Enable or disable Show LED. If Show LED is disabled, the alarm and status LEDs on the logger are not illuminated while logging (the alarm LED does not blink if an alarm trips). You can temporarily turn on LEDs when Show LED is disabled by pressing the button on the logger for 1 second.
11. Enable or disable Bluetooth Always On. If Bluetooth Always On is enabled, the logger advertises or regularly sends out a Bluetooth signal for the phone, tablet, or computer to find via the app while it is logging, which uses battery power. When Bluetooth Always On is disabled, the logger only advertises during logging when the button on the logger is pressed to wake it up, thereby preserving as much battery power as possible.
12. Select Soil Type:
 - Mineral – for common soils, with EC values up to 8 dS/m.
 - Soilless – for potting soils, perlite, and peat moss with EC values up to 8 dS/m.
 - Apparent Dielectric Permittivity – raw measurements that can be used in published equations such as the Topp equation to derive soil moisture data.
13. Enable or disable Percent of Field Capacity – To see soil moisture as the percent of field capacity, enable this and enter the field capacity for the soil at the site in Volumetric Water Content on a scale of 0.01 to 1.00. Note that the Percent of Field Capacity values reported are limited to the range of 0% to 200%. If you select Apparent Dielectric Permittivity as your soil type, the option for Percent of Field Capacity is disabled.
14. Select whether to upload data to HOBOLink using the HOBOLink app or the MX Gateway. Uploading data to HOBOLink requires that you create a HOBOLink account. If you offload data using HOBOLink you don't need to upload your data to HOBOLink. If you are using the Gateway you must have a HOBOLink account.
15. Enable/Disable the sensors to log (MX2307 model) and set up any alarms to trip when a sensor reading rises above or falls below a specified value. See *Setting up Alarms* for details on enabling sensor alarms. Note that for the MX2307, temperature is Channel 3. Channel 2 is reserved for Apparent Dielectric Permittivity, if you select it.
16. Tap Start to save the configuration settings, and start logging based on the settings you selected. Press the start button on the logger if it was set up to start logging with a button push. See *Deploying and Mounting the Logger* for details on mounting and see *Reading Out the Logger* for details on downloading.

Setting up Alarms

You can set an alarm to trip on the logger when a sensor reading rises above or falls below a specified value. Alarms alert you to problems so you can take corrective action. To set an alarm:

1. Tap Devices.
2. Tap the logger tile in the app to connect to the logger and tap Configure & Start.
3. Tap a Sensor/Channel and tap Enable Logging, if necessary.
4. Tap Alarms to open that area of the screen.
5. Select Low if you want an alarm to trip when the sensor reading falls below the low alarm value. Enter a value to set the low alarm value.
6. Select High if you want an alarm to trip when the sensor reading rises above the high alarm value. Enter a value to set the high alarm value.
7. For the Duration, select how much time should elapse before the alarm trips and select one of the following:
 - **Cumulative Samples.** The alarm trips once the sensor reading is out of the acceptable range for the selected duration any time during logging. For example, if the high alarm is set to 85°F and the duration is set to 30 minutes, the alarm trips once the sensor readings have been above 85°F for a total of 30 minutes since the logger was configured.
 - **Consecutive Samples.** The alarm trips once the sensor reading is out of the acceptable range continuously for the selected duration. For example, the high alarm is set to 85°F and the duration is set to 30 minutes, the alarm trips only if all sensor readings are 85°F or above for a continuous 30-minute period.
8. For the MX2307, repeat steps 2–7 for the other sensor.
9. In the Alarm Settings area, select one of the following options to determine how the alarm indications are cleared:
 - **Logger Reconfigured.** The alarm icon indication appears until the next time the logger is reconfigured.
 - **Sensor in Limits.** The alarm icon indication displays until the sensor reading returns to the normal range between any configured high and low alarm limits.

When an alarm trips, the logger alarm LED blinks every 4 seconds (unless Show LED is disabled), an alarm icon appears in the app, and an Alarm Tripped event is logged. The alarm state clears when the readings return to normal if you have specified Sensor in Limits in step 9. Otherwise, the alarm state remains in place until the logger is reconfigured.

Notes:

- The logger checks alarm limits at every logging interval. For example, if the logging interval is set to 5 minutes, the logger checks the sensor readings against the configured high and low alarm setting every 5 minutes.
- The actual values for the high and low alarm limits are set to the closest value supported by the logger. In addition, alarms can trip or clear when the sensor reading is within the resolution specifications.
- When downloading data from the logger, alarm events can be displayed on the plot or in the data file. See *Logger Events*.

Burst Logging

Burst logging is a logging mode that allows you to set up more frequent logging when a specified condition is met. For example, an MX2307 logger is recording data at a 5-minute logging interval and burst logging is configured to log every 30 seconds when the temperature rises above 85°F (the high limit) or falls below 32°F (the low limit). This means the logger records data every 5 minutes as long as the temperature remains between 85°F and 32°F. Once the temperature rises above 85°F, the logger switches to the faster logging rate and records data every 30 seconds until the temperature falls back to 85°F. At that time, logging resumes every 5 minutes at the fixed logging interval. Similarly, if the temperature falls below 32°F, the logger switches to burst logging mode again and records data every 30 seconds. Once the temperature rises back to 32°F, the logger returns to fixed mode, logging every 5 minutes. **Note:** Sensor alarms, statistics, and the Stop Logging option Never Stop (Overwrites Old Data) are not available in burst logging mode.

To set up burst logging:

1. Tap Devices. Press the button on the logger to wake it up (if necessary).
2. Tap the logger tile in the app to connect to the logger and tap Configure & Start.
3. Tap Logging Mode and then tap Burst Logging.
4. Set the burst logging interval, which must be faster than the logging interval. Keep in mind that the faster the burst logging rate, the greater the impact on battery life and the shorter the logging duration. Because measurements are being taken at the burst logging interval throughout the deployment, the battery usage is similar to what it would be if you had selected this rate for the fixed logging interval.
5. Select Low and/or High and type a value to set the low and/or high values.

Notes:

- The high and low burst limits are checked at the burst logging interval rate whether the logger is in fixed or burst condition. For example, if the logging interval is set to 1 hour and the burst logging interval is set to 10 minutes, the logger always checks for burst limits every 10 minutes.
- If high and/or low limits are configured for more than one sensor, burst logging begins when any high or low condition goes out of range. Burst logging does not end

until all conditions on all sensors are back within normal range.

- The actual values for the burst logging limits are set to the closest value supported by the logger.
- Burst logging can begin or end when the sensor reading is within the resolution specifications. This means the value that triggers burst logging may differ slightly from the value entered.
- Once the high or low condition clears, the logging interval time is calculated using the last recorded data point in burst logging mode, not the last data point recorded at the fixed logging rate. For example, the logger has a 10-minute logging interval and logged a data point at 9:05. Then, the high limit is surpassed and burst logging begins at 9:06. Burst logging then continues until 9:12 when the sensor reading falls back below the high limit. Now back in fixed mode, the next logging interval is 10 minutes from the last burst logging point, or 9:22 in this case. If burst logging had not occurred, the next data point would have been at 9:15.
- A New Interval event is created each time the logger enters or exits burst logging mode. See *Logger Events* for details on plotting and viewing the event. In addition, if the logger is stopped with a button push while in burst logging mode, a New Interval event is automatically logged and the burst condition is cleared, even if the actual high or low condition has not cleared.

Statistics Logging

During fixed logging, the logger records data for enabled sensors and/or selected statistics at the logging interval selected. Statistics are calculated at a sampling rate you specify with the results for the sampling period recorded at each logging interval. The following statistics can be logged for each sensor:

- The maximum, or highest, sampled value
- The minimum, or lowest, sampled value
- An average of all sampled values
- The standard deviation from the average for all sampled values

For example, an MX2307 logger is configured with both the soil moisture and temperature sensors enabled, and the logging interval is set to 5 minutes. The logging mode is set to fixed logging and all four statistics enabled and with a statistics sampling interval of 30 seconds. Once logging begins, the logger measures and records the actual soil moisture and temperature sensor values every 5 minutes. In addition, the logger takes a soil moisture and temperature sample every 30 seconds and temporarily stores them in memory. The logger then calculates the maximum, minimum, average, and standard deviation using the samples gathered over the previous 5-minute period and log the resulting values. When reading out the logger, this results in 10 data series: two sensor series (with soil moisture and temperature logged every 5 minutes) plus eight maximum, minimum, average, and standard deviation series (four for soil moisture and four for temperature with values calculated and logged every 5 minutes based on the 30-second sampling).

To log statistics:

1. Tap Devices. Press the button **on the logger** to wake it up, if necessary.
2. Tap the logger tile in the app to connect to the logger and tap Configure & Start.
3. Tap Logging Mode and select Fixed Logging Mode.
4. Tap to turn on Statistics.

Note: Fixed Logging Mode records sensor measurements taken at each logging interval. The selections you make in the Statistics section add measurements to the recorded data.

5. Select the statistics you want the logger to record at each logging interval: Maximum, Minimum, Average, and Standard Deviation (average is automatically enabled when selecting Standard Deviation). Statistics are logged for all enabled sensors. In addition, the more statistics you record, the shorter the logger duration and the more memory is required.
6. Tap Statistics Sampling Interval and select the rate to use for calculating statistics. The rate must be less than, and a factor of, the logging interval. For example, if the logging interval is 1 minute and 5 seconds was selected for the sampling rate, the logger takes 12 sample readings between each logging interval (one sample every 5 seconds for a minute) and use the 12 samples to record the resulting statistics at each 1-minute logging interval. Note that the faster the sampling rate, the greater the effect on battery life. Because measurements are being taken at the statistics sampling interval throughout the deployment, the battery usage is similar to what it would be if you had selected this rate for the fixed logging interval.

Setting a Password

You can create an encrypted password for the logger that is required if another device attempts to connect to it. This is recommended to ensure that a deployed logger is not mistakenly stopped or purposely altered by others. This password uses a proprietary encryption algorithm that changes with every connection.

To set a password:

1. Tap Devices. Press the Start/Stop button **on the logger** to wake it up, if necessary. Tap the logger tile in the app to connect to it.
2. Tap Lock Logger.
3. Type a password and then tap Set.

Only the device used to set the password can then connect to the logger without entering a password; all other devices are required to enter the password. For example, if you set the password for the logger with your tablet and then try to connect to the logger later with your phone, you must enter the password on the phone but not with your tablet. Similarly, if others attempt to connect to the logger with different devices, they are also required to enter the password. To reset a password, press the button on the logger for 10 seconds or connect to the logger and tap Manage Password and tap Reset.

Downloading Data From the Logger

To download data from the logger:



1. Tap Devices. Press the button **on the logger** to wake it up, if necessary. Tap the logger tile in the app to connect to the logger.
2. Tap Download Data. The logger downloads data to the phone, tablet, or computer.
3. Once the download is complete, tap Done to return to the previous page or tap Export and Share to save the file in the specified format.
4. When the export file has successfully been created, tap Done to return to the previous page or tap Share to use your device's usual modes of sharing.

You can also upload data automatically to HOBOLink, Onset's web-based software, using the app or the MX gateway. For details, see the HOBOLink User Guide and see the HOBOLink help for details on working with data in HOBOLink.

Logger Events

The logger records the following internal events to track logger operation and status. You can view events in exported files or plot events in the app.

To plot events, tap HOBO Files and select a file to open.

Tap  (if applicable) and then tap . Select the events you want to plot and tap OK.

Internal Event Name	Definition
Host Connected	The logger was connected to the mobile device.
Started	The logger started logging.
Stopped	The logger stopped logging.
Alarm Tripped/Cleared	An alarm has occurred because the reading was outside the alarm limits or back within range. Note: Although the reading may have returned to a normal range during logging, an alarm cleared event will not be logged if the logger was set up to maintain alarms until reconfigured.
New Interval	The logger has switched to logging at the burst logging rate or back to the normal rate.
Safe Shutdown	The battery level dropped below a safe operating voltage and the logger performed a safe shutdown.

Installing the Soil Moisture Sensor

There are two installation methods for installing the soil moisture sensor: borehole or trench.

Borehole Installation Method

This method allows for a profile of soil moisture sensors to be installed at different depths within a single augered borehole, thereby minimizing soil disturbance at the measurement site. A 10-cm (4-inch) borehole is augered vertically at the measurement location. You can then carefully insert and place

the sensor by hand or buy or rent the Borehole Installation Tool from Meter (recommended for depths greater than 50 cm (19.7 inches). Email Meter at info@metergroup.com (North America) or info.europe@metergroup.com (Europe) for details on buying or renting the tool.

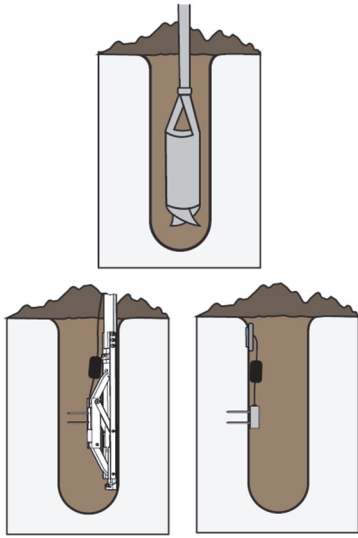

If installing the sensor without the Borehole Installation Tool, look down the hole with a flashlight, reach in with the sensor and push it into the side of the undisturbed soil. Look down the hole again and make sure it is firmly seated. You can also consider attaching the sensor to PVC piping or similar material to aid in placing the sensor. You can then use the PVC as a lever to assist with pushing the sensor into the undisturbed soil.

Trench Installation Method

This method is best for shallow installations at less than 40 cm (15.7 inches). This requires digging a trench with a shovel, excavator, or other tool to the depth of the deepest installed sensor (if installing more than one in the same location). For deep installations, this may require a large trench. Install the sensor carefully by hand into the undisturbed soil of the trench sidewall. Carefully fully backfill the trench to preserve the bulk density of the soil and avoid dislodging the installed sensor by accidentally snagging the ferrite core.

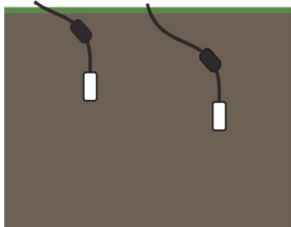

Sensor Installation Guidelines

Before installing the sensor, follow these guidelines:

- Test the sensor functionality and accuracy using the TEROS verification clip. With the verification clip attached, the readings should be in the range of 0.35 to 0.42 m³/m³. Refer to the TEROS verification clip documentation for more information. If you do not have a verification clip, you can perform a rough check of sensor functionality in air and water. The sensor will produce readings of ~0.64 m³/m³ in water (sensor fully submerged in water to 1 cm

up cable) and slightly negative in air. Use HOBOnnect to export or view the data for your test.

- When creating the hole to install the sensor, avoid interfering objects. Installation near large metal objects can affect the sensor function and distort readings. Large objects like roots or rocks could potentially bend the needles.
- The sensor may be positioned in any direction. However, there is less restriction to water flow when the sensor body is placed in a vertical position as shown below. A vertical position will also integrate more soil depth into the soil moisture measurement. Installing the sensor with the sensor body in a horizontal position will provide measurements at a more discreet depth.



- Avoid any metal located between the sensor and the ferrite core; it can interfere with VWC measurements.
- When installing sensors in rocky soils, use care to avoid bending sensor needles.
- Minimize air gaps around the sensor. Air gaps around the sensor needles will result in low readings of soil moisture.
- Use conduit to protect the cable against damage from animals, lawn mowers, exposure to chemicals, etc.
- Secure any loose cables with cable ties.

Sensor Installation Instructions

1. Auger or dig a hole to the desired sensor depth.
2. Carefully insert the sensor in the hole and push the sensor so that the needles are inserted into the undisturbed side of the soil. Check that the sensor is firmly seated.
3. If using the temperature sensor for soil temperature, insert that into the side of the hole, at least 2 cm (1 inch) from the soil moisture sensor and ferrite core.
4. Secure the cable(s) and install conduit before backfilling the hole.
5. Carefully return the soil to the hole, packing it back to its native bulk density. Do not hit the ferrite core as this could pull the sensor from the soil.
6. If using the MX2307 logger for air temperature, a solar radiation shield is required if the temperature sensor will be in sunlight at any time. (See Accessories)

Deploying and Mounting the Logger

Follow these guidelines when deploying the logger:

- Mount the logger so the sensor cable is coming out the bottom of the logger and not being pulled. Leave about 5

cm (2 inches) of drip loop in the cable where it comes out of the logger to prevent water from entering the logger housing.

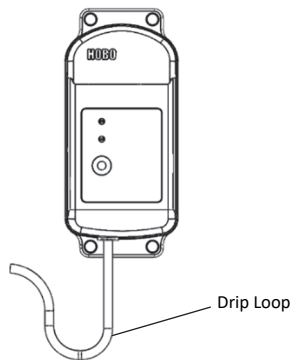

- Mount the logger high enough so that it will not get submerged during a rain storm.
- Use the included large screws or cable ties to mount the logger via the mounting holes. Use the screws to attach the logger to a wall or flat surface. Use the cable ties to affix the logger to a PVC pipe or mast. Make sure that the logger case is not bent when the logger is mounted as that could lead to water entry.

Protecting the Logger

Note: Static electricity may cause the logger to stop logging. The logger has been tested to 8 KV, but avoid electrostatic discharge by grounding yourself to protect the logger. For more information, search for “static discharge” on onsetcomp.com.

Maintenance

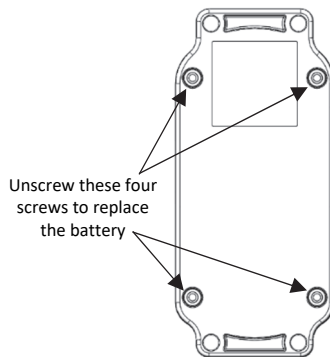

To clean the soil moisture sensor and needles, use a mild detergent, such as liquid dish soap, and a nonabrasive sponge or cloth. Avoid detergents that contain lotions or moisturizers. Rinse the sensor and needles thoroughly with tap or deionized (DI) water. The logger is designed for outdoor use, but should be inspected periodically. Wipe off any dust or grime with a damp cloth.

Troubleshooting

If the soil moisture sensor readings are too low or slightly negative, check for air gaps around the sensor needles. These could be produced below the surface of the substrate when the needle contacts a large piece of material and pushes it out of the way, or if the sensor is not inserted perfectly linearly.

If the sensor readings are too high, make sure the media was not packed excessively or insufficiently during sensor installation. Higher density can cause the sensor readings to be elevated.

Battery Information

The logger requires one user-replaceable 2/3 AA 3.6 V lithium battery (HRB-2/3AA). Battery life is 2 years, typical with a logging interval of 1 minute, but may be extended to 5 years when the logger is configured with Bluetooth Always On disabled. Expected battery life varies based on the ambient temperature where the logger is deployed, the logging or sampling interval, frequency of offloading and connecting to the mobile device, number of channels that are active, and use of burst mode or statistics logging. Deployments in extremely cold or hot temperatures or logging interval faster than 1 minute can impact battery life. Estimates are not guaranteed due to uncertainties in initial battery conditions and operating environment.

Replacing the Battery

1. Use a Phillips-head screwdriver to unscrew the four screws from the back of the logger.
2. Carefully separate the top and bottom of the logger enclosure.
3. Remove the old battery and insert the new battery observing polarity. It is recommended that you replace the desiccant (DESICCANT2) when replacing the battery.
4. Make sure the rubber seal is clean and free of any debris and then carefully reassemble the logger enclosure and screw in the four screws.

⚠ WARNING: Do not cut open, incinerate, heat above 85°C (185°F), or recharge the lithium battery. The battery may explode if the logger is exposed to extreme heat or conditions that could damage or destroy the battery case. Do not dispose of the logger or battery in fire. Do not expose the contents of the battery to water. Dispose of the battery according to local regulations for lithium batteries.

Federal Communication Commission Interference Statement

This equipment has been tested and found to comply with the limits for a Class B digital device, pursuant to Part 15 of the FCC Rules. These limits are designed to provide reasonable protection against harmful interference in a residential installation. This equipment generates uses and can radiate radio frequency energy and, if not installed and used in accordance with the instructions, may cause harmful interference to radio communications. However, there is no guarantee that interference will not occur in a particular installation. If this equipment does cause harmful interference to radio or television reception, which can be determined by turning the equipment off and on, the user is encouraged to try to correct the interference by one of the following measures:

- Reorient or relocate the receiving antenna
- Increase the separation between the equipment and receiver
- Connect the equipment into an outlet on a circuit different from that to which the receiver is connected
- Consult the dealer or an experienced radio/TV technician for help

This device complies with Part 15 of the FCC Rules. Operation is subject to the following two conditions: (1) This device may not cause harmful interference, and (2) this device must accept any interference received, including interference that may cause undesired operation.

FCC Caution: Any changes or modifications not expressly approved by the party responsible for compliance could void the user's authority to operate this equipment.

Industry Canada Statements

This device complies with Industry Canada license-exempt RSS standard(s). Operation is subject to the following two conditions: (1) this device may not cause interference, and (2) this device must accept any interference, including interference that may cause undesired operation of the device.

Avis de conformité pour l'Industrie Canada

Le présent appareil est conforme aux CNR d'Industrie Canada applicables aux appareils radio exempts de licence. L'exploitation est autorisée aux deux conditions suivantes : (1) l'appareil ne doit pas produire de brouillage, et (2) l'appareil doit accepter tout brouillage radioélectrique subi, même si le brouillage est susceptible d'en compromettre le fonctionnement. To comply with FCC and Industry Canada RF radiation exposure limits for general population, the logger must be installed to provide a separation distance of at least 20cm from all persons and must not be co-located or operating in conjunction with any other antenna or transmitter.

