



RXW Ultrasonic Wind Speed & Direction Sensor

Models:

- RXW-WCG-900 (US)
- RXW-WCG-868 (Europe)
- RXW-WCG-921 (Taiwan)
- RXW-WCG-922 (Australia/NZ)

Included Items:

- North alignment tool
- U-bolts with hex nuts, brackets, spacers, and lock nuts for mounting on a mast or cross arm

Required Items:

- Phillips-head screw driver
- 10 mm wrench (if mounting on a mast or cross arm)
- Screws and drill (if mounting on a vertical surface)

Accessories:

- Grounding kit (M-GKA)

This sensor measures wind speed, gust speed, and wind direction and is designed to work with the HOBOnet® (HOBOnet® RX) Wireless Sensor Network in which data is transmitted wirelessly from the sensor mote across the network to the station and then uploaded to HOBOLink® web-based software. With HOBOLink, you can monitor sensor readings, view graphs, set up alarms, download data, and more.

Specifications

Sensor	Wind Speed/Gust	Wind Direction
Measurement Range	0 to 41.16 m/s (0 to 92.07 mph)	0 to 359 degrees
Accuracy	±0.8 m/s (1.79 mph) or ±4% of reading, whichever is greater	0.2 to 3 m/s (0.44–6.7 mph): ±4 degrees >3 m/s (6.7 mph): ±2 degrees
Resolution	0.4 m/s (0.89 mph)	1 degree (0 to 359 degrees)
Measurement Definition	Wind speed readings are taken every three seconds for the duration of the logging interval Wind speed: Average speed for the entire logging interval Gust speed: The highest three-second wind recorded during the logging interval See <i>Measurement Operation</i> .	Unit vector averaging used; vector components for each wind measurement are calculated every three seconds for duration of logging interval (see <i>Measurement Operation</i>)
Operating Temperature Range Without Icing	-15°C to 55°C (5°F to 131°F)	
Wireless Mote		
Operating Temperature Range	-25° to 60°C (-13° to 140°F) with rechargeable batteries -40° to 70°C (-40° to 158°F) with lithium batteries	
Radio Power	12.6 mW (+11 dBm) non-adjustable	
Transmission Range	Reliable connection to 457.2 m (1,500 ft) line of sight at 1.8 m (6 ft) high Reliable connection to 609.6 m (2,000 ft) line of sight at 3 m (10 ft) high	
Wireless Data Standard	IEEE 802.15.4	
Radio Operating Frequencies	RXW-WCG-900: 904–924 MHz RXW-WCG-868: 866.5 MHz RXW-WCG-921: 921 MHz RXW-WCG-922: 916–924 MHz	
Modulation Employed	OQPSK (Offset Quadrature Phase Shift Keying)	
Data Rate	Up to 250 kbps, non-adjustable	
Duty Cycle	<1%	
Maximum Number of Motes	Up to 50 wireless sensors or 336 data channels per one HOBOnet RX station	
Logging Rate	1 minute to 18 hours	
Number of Data Channels	4	
Battery Type/Power Source	Sensor: Photovoltaic panel, LIFEP04 3.2 V -600 mAh battery Mote: Two AA 1.2 V rechargeable NiMH batteries powered by built-in solar panel or two AA 1.5 V lithium batteries for operating conditions of -40° to 70°C (-40° to 158°F)	
Battery Life	With NiMH batteries: Typical 3–5 years when operated in the temperature range -20° to 40°C (-4°F to 104°F) and positioned toward the sun (see <i>Deployment and Mounting</i>), operation outside this range will reduce the battery service life With lithium batteries: 1 year, typical use	
Memory	16 MB	

Specifications (continued)

Dimensions	Sensor length: 380 mm (14.96 inches) Sensor head diameter: 60 mm (2.36 inches) Sensor rod diameter: 16 mm (0.63 inches) Cable length: 3 m (9.8 ft) Mote: 16.2 x 8.59 x 4.14 cm (6.38 x 3.38 x 1.63 inches)
Weight	Sensor and cable: 200 g (7 oz) Mote: 223 g (7.87 oz)
Materials	Sensor: Polyacetal Mote: PCPBT, silicone rubber seal
Environmental Rating	Sensor and cable: Weatherproof Mote: IP67, NEMA 6
Compliance Marks	<p>FC RXW-WCG-900: See last page</p> <p>CE RXW-WCG-868: The CE Marking identifies this product as complying with all relevant directives in the European Union (EU).</p> <p>CCC RXW-WCG-921: See last page</p> <p>RoHS RXW-WCG-922: See last page</p>

Mote Components and Operation

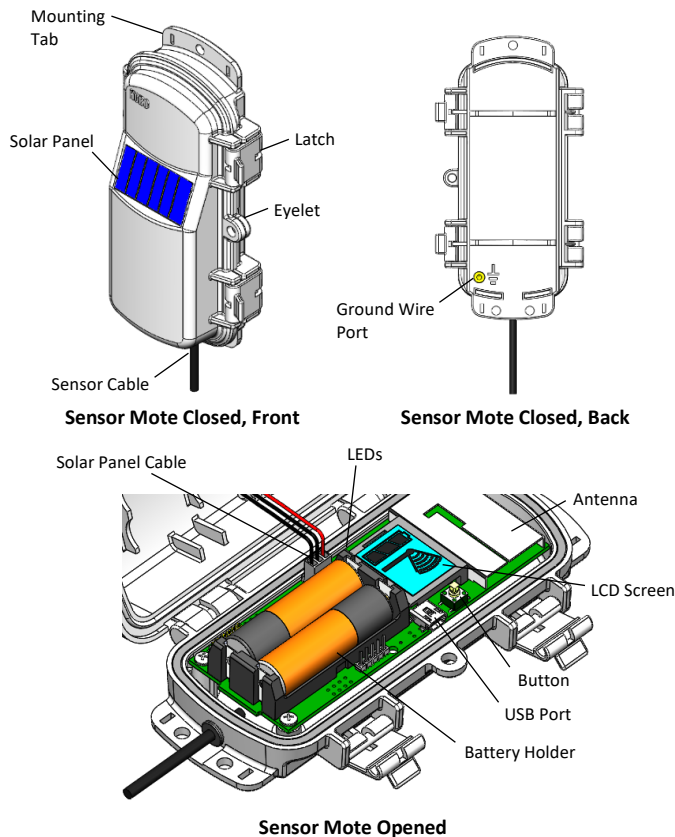

Mounting Tab: Use the tabs at the top and bottom of the mote to mount it (see *Deploying and Mounting*).

Solar Panel: Position the solar panel towards the sun to charge the mote batteries (see *Deploying and Mounting*).

Sensor Cable: This is the cable that connects the mote to the sensor.

Eyelet: Use this eyelet to attach a 3/16 inch padlock to the mote for security.

Latch: Use the two latches to open and close the mote door.

Ground Wire Port: Use this port to connect a ground wire (see *Deploying and Mounting*).

Antenna: This is the built-in antenna for the radio communications across the HOBOnet Wireless Sensor Network.

LEDs: There are two LEDs to the left of the LCD screen. The green LED blinks during the process of joining a network, blinking quickly while the mote searches for a network and then slowly as the mote registers with the network. Once the network registration process is complete, the blue LED blinks at 4 seconds to indicate normal operation. If the mote is not currently part of a network, the blue LED will be off. If the blue LED is on and not blinking, there is a problem with the mote. Contact Onset Technical Support.

Solar Panel Cable: This cable connects the built-in solar panel to the mote circuitry.





Battery Holder: The location where the batteries are installed as shown (see *Battery Information*).

USB Port: Use this port to connect to the mote to a computer via USB cable if you need to update the firmware (see *Updating Mote Firmware*).

Button: Push this button for 1 second to illuminate the LCD or 3 seconds for the mote to search for a HOBOnet Wireless Sensor Network to join (see *Adding the Mote to the HOBOnet Wireless Sensor Network*).

LCD Screen: The mote is equipped with an LCD screen that displays details about the current status. This example shows all symbols illuminated on the LCD screen followed by definitions of each symbol in the table.



LCD Symbol	Description
	The battery indicator shows the approximate battery charge remaining.
	This is a signal strength indicator. The more bars, the stronger the signal between motes. If there is no x icon next to the signal strength indicator, then the mote is part of a HOBOnet Wireless Sensor Network.
	An empty signal strength icon plus the x icon indicates that the mote is not currently part of a network. See <i>Adding the Mote to the HOBOnet Wireless Sensor Network</i> for details on how to add a mote to the network.
	When the mote is in the process of joining a network, the signal strength icon will blink and then the bars in the icon will cycle from left to right. The x icon will blink during the last step in the network registration process (see <i>Adding the Mote to the HOBOnet Wireless Sensor Network</i> for details).
	This indicates a problem with the sensor itself (the mote is operational). Check the sensor and make any adjustments to it as needed. Contact Onset Technical Support if the problem persists.

Connecting the Sensor Battery

The sensor includes a factory-installed battery that has been disconnected for shipping. When connected, this rechargeable battery is charged by the solar panel on the top of the sensor head. Follow these instructions for connecting the battery.

Important: It is recommended that you only connect the battery when you are ready to deploy the sensor because it will require regular, direct sunlight to remain charged. Once the battery is connected, it will lose its charge after 10 days if it does not receive any sunlight. **In addition, you must place the sensor under a light source for at least one minute after the battery is connected to activate the sensor.**

To connect the sensor battery:

1. Connect the two battery cables.

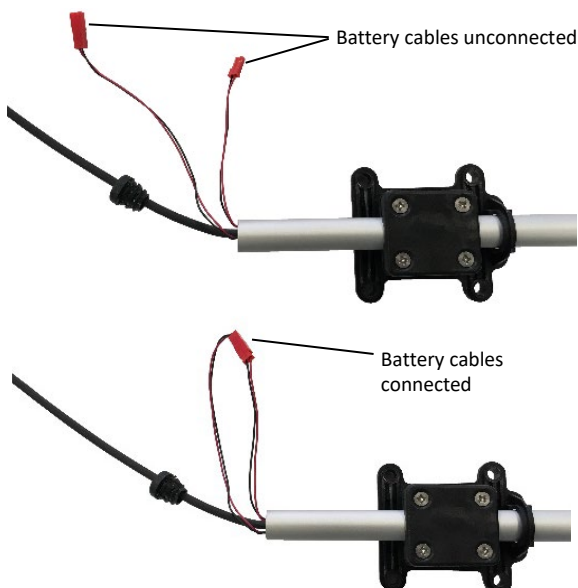

2. Insert the connected battery cables into the sensor rod tube.

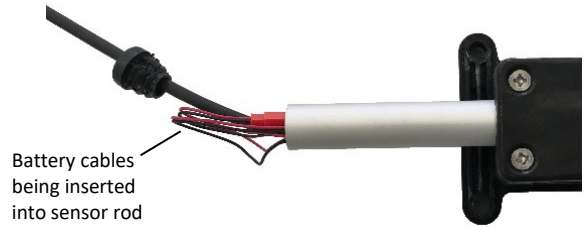

3. Once the cables are fully inserted, push and twist the cap into place at the end of the sensor rod.



The cap should be fully seated in the sensor rod without any gaps as shown below. If there is a gap, remove the cap and push the battery cables further in the sensor rod to make more room for the cap.

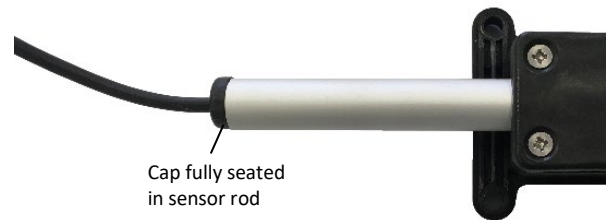

4. Slide the sensor rod up so that the bottom is flush with the bottom of the sensor base. Loosely tighten the four screws to keep the sensor rod in place.



5. Place the solar panel on the top of the sensor under a light source (a bright lamp or direct sunlight) for at least one minute to activate the sensor.

Once these steps are complete, add the mote to the network as described in the next section.

Adding the Mote to the HOBONet Wireless Sensor Network

The mote must join a HOBONet Wireless Sensor Network before it can begin measuring temperature and transmitting data. This requires accessing the station and the mote at the same time so it is recommended that you complete these steps before deploying the mote.

Important: If you are setting up a new station, follow the instructions in the station quick start before setting up this mote (go to www.onsetcomp.com/support/manuals/24380-man-rx2105-rx2106-qsg for RX2105 and RX2106 stations or go to www.onsetcomp.com/support/manuals/18254-MAN-QSG-RX3000 for RX3000 stations).

To add a mote to the network:

1. If the LCD is blank on the station, press any button to wake it up.
2. Press the Select button once (which shows the number of smart sensors installed) and then press it again to switch to the module with the manager (module 2 on RX2105 or RX2106 stations).

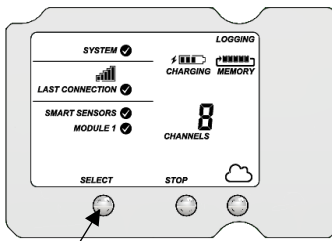

Press this button to view the module

3. Press the Search button (the magnifying glass). The magnifying glass icon will blink while the station is in search mode.

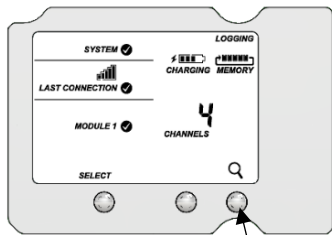

Press this button so the station is ready to have motes join the network

4. Open the mote door and install the batteries if you have not already done so.
5. Press the button on the mote for 3 seconds. The signal strength icon will flash and then cycle.

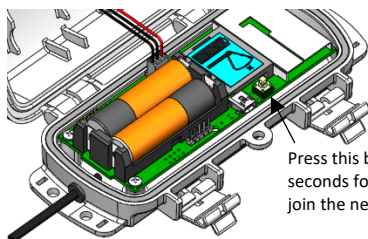

Press this button for 3 seconds for the mote to join the network

6. Watch the LCD on the mote.

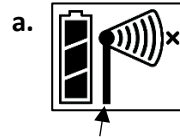

This signal strength icon blinks while searching for a network.



Once a network is found, the icon will stop flashing and the bars will cycle from left to right.



This network connection "x" icon blinks while the mote completes the registration process, which may take up to five minutes.



Once the mote has finished joining the network, the "x" icon is removed and the channel count on the station LCD increases by four (three for wind speed, wind direction, and gust speed, and one for the mote battery).

This process may take up to five minutes. The green LED blinks quickly while the mote searches for a network to join and then blinks slowly while it completes the network registration. Once the mote has finished joining the network, the green LED turns off and the blue LED then blinks indefinitely while the mote is part of the network.

Note: If the mote cannot find the network or has trouble remaining connected during this process, make sure the mote is in a vertical, upright position and within range of the station.

7. Press the Search button (the magnifying glass) on the station to stop searching for motes.

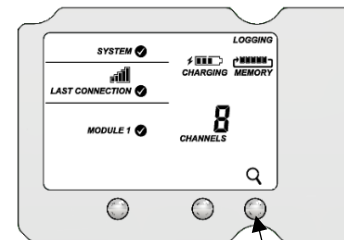

Press this button again to stop searching for motes

If you added more than one more mote to the network, then the total channel count on the station LCD for the manager module will represent all measurement channels plus a battery channel for each mote in the HOBONet Wireless Sensor Network.

Sensor measurements will be recorded at the logging interval specified in HOBOLink, transmitted to the station, and uploaded to HOBOLink at the next connection interval (readout). Use HOBOLink to monitor mote status and health. If a mote is temporarily offline, any logged data is saved until it is back online. In addition, if a mote is offline for 30 minutes, the station will automatically connect to HOBOLink and report the mote as missing. Once the mote is back online, any logged data will be uploaded the next time the station connects to HOBOLink.

See the HOBOLink Help for details on how to change the logging and connection intervals, view data, check mote status, add the mote to a map, and more.

Deployment and Mounting

Mounting and Positioning the Mote

- Mount the mote to a mast or pipe using cable ties or affix the mote to a wooden post or flat surface with screws. Insert the cable ties or screws through the holes on the mounting tabs.
- Consider using plastic poles such as PVC to mount the mote as certain types of metal could decrease signal strength.
- Make sure the mote remains in a vertical position once it is placed in its deployment location for optimal network communications.
- Make sure the mote door is closed, with both latches fully locked to ensure a watertight seal.
- Consider using a 3/16 inch padlock to restrict access to the mote. With the mote door closed, hook a padlock through the eyelet on the right side of the door and lock it.
- Position the mote towards the sun, making sure the solar panel is oriented so that it receives optimal sunlight throughout each season. It may be necessary to periodically adjust the mote position as the path of the sunlight changes throughout the year or if tree and leaf growth alters the amount of sunlight reaching the solar panel.
- Make sure the mote is mounted a minimum of 1.8 m (6 ft) from the ground or vegetation to help maximize distance and signal strength.
- Place the mote so there is full line of sight with the next mote. If there is an obstruction between two sensor motes or between the sensor mote and the manager, then use a repeater mounted on the obstruction. For example, if there is a hill between the sensor mote and the manager, place a repeater at the top of the hill between the sensor mote and the manager.
- There should not be more than five motes in any direction at their maximum transmission range from the manager. Data logged by a wireless sensor must travel or “hop” across the wireless network from one mote to the next until it ultimately reaches the manager connected to the station. To make sure the data can successfully travel across the network, the mote should not be more than five hops away from the manager.
- The HOBONet Wireless Sensor Network can support up to 50 wireless sensors or 336 data channels per one HOBONet RX station.
- Use a #4-40 screw to attach a ground wire to the port on the back of the mote if you are deploying the mote in a location where lightning is a concern.

Sensor Mounting Guidelines

- The sensor can be damaged with improper handling. Store the sensor in its shipping box until you are ready to install it.

- Mount the sensor in the sunlight within 10 days of connecting the battery to prevent it from losing all charge.
- Choose a location free of turbulence and magnetic fields resulting from electricity, engines, radio transmitters, radars, etc.
- For the most accurate readings, the sensor should be mounted 3 m (9.8 ft) or more above the ground and 10 m (32.8 ft) away from nearby objects.
- When mounting the sensor on a roof, the sensor must be mounted at a height equal to the building’s length or five times the building’s height. Install the sensor in the middle of the roof when possible. You may do this by mounting the sensor on an Onset tripod or mast, or a metal pipe. It is not recommended to install the sensor on a slanted roof because it can generate upwards turbulence that will affect the sensor measurements.
- You may mount the sensor on a wooden post.
- Mount the sensor in a location that receives direct sunlight for several hours a day to ensure the built-in solar panel is charged regularly. Make sure the sensor is positioned in the sun and not under the forest canopy or obstructions.
- The sensor must be aligned to true north when mounted to ensure accurate wind direction readings. Use the alignment tool as described *North Alignment*.
- If the sensor is mounted on the same mast as a rain gauge, mount the wind sensor away from the rain gauge on a half cross arm (M-CAB) so that the wind sensor does not interfere with rainfall measurements. If there is no rain gauge on the same mast, mount the wind sensor directly to the top of the mast.
- The tripod or mounting mast must be properly grounded. For field installations, you can use Onset’s Grounding Kit (M-GKA).
- If the station is deployed in an area subject to frequent thunderstorms, installing a lightning rod nearby can reduce the risk of damage.
- To minimize measurement errors due to ambient RF, keep the sensor cable as far as possible from other cables carrying high frequency or high-current signals.
- Secure the sensor cable with cable clips or weather resistant cable ties to protect it from damage in the wind. Place clips or cable ties approximately every 1 to 1.6 m (3 to 5 ft). Do not use metal staples to secure the cable as they can cut the cable.
- Secure the mast that the sensor is mounted on so that it does not vibrate. If you are using an Onset mast or tripod, secure it with guy wires.

Mounting the Sensor on a Mast

Follow these instructions for mounting the sensor on a tripod or mast. The mounting U-bolts included can be used for mounting the sensor on a mast or tripod with an outside diameter ranging from 35–48 mm (1.38–1.89 inches).

1. Connect the battery if you haven’t already done so (see *Connecting the Sensor Battery*).
2. Place the mounting U-bolt around the mast and slide the bracket over the threaded U-bolt ends as shown in this

example. Make sure the flat part of the bracket is facing out.

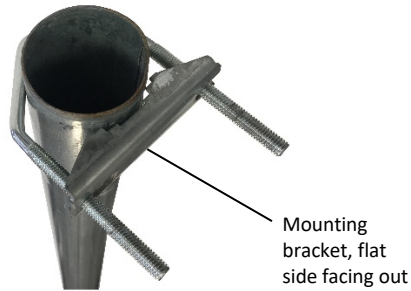

3. Repeat step 2 with the other U-bolt and bracket.
4. Insert the ends of the U-bolts through the four holes in the square sensor base at the bottom of the sensor rod. Loosely install the hex nuts on the four bolt ends with a 10 mm wrench.

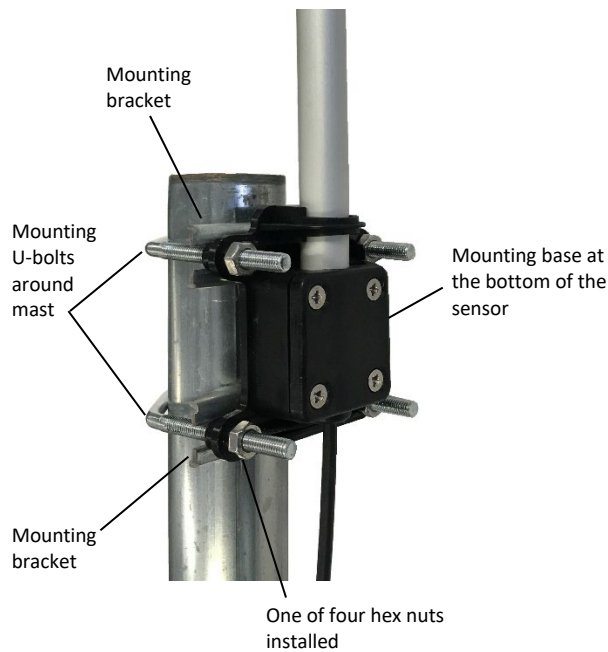

5. Raise the sensor to the desired height on the mast.
6. Use the wrench to tighten the hex nuts until the sensor is firmly fastened on the mast. Do not overtighten the hex nuts.
7. Follow the steps in *North Alignment* to make sure the sensor is pointed to true north.

Mounting the Sensor on a Tripod Cross Arm

Follow these instructions for mounting the sensor on a cross arm.

1. Attach the cross arm to the mast before installing the sensor.
2. Connect the battery if you haven't already done so (see *Connecting the Sensor Battery*).
3. Use a 10 mm wrench to install two hex nuts at the base of the threaded end of the U-bolts as shown. Tighten the hex

nuts all the way down to the end of the threads. Repeat with the other U-bolt.

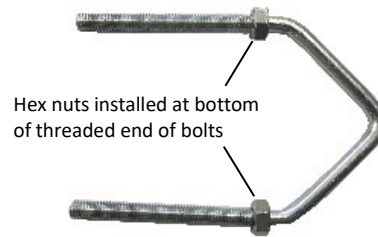

4. Insert the threaded bolt end through the hole in the bracket so that the bracket rests on top of the hex nut with the flat end facing out. Place a spacer on top of the bracket as shown below. Repeat for the other threaded bolt end and for both ends of the other U-bolt.

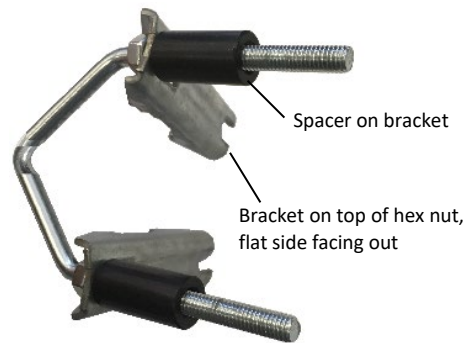

5. Insert both bolt assemblies through the bottom of the mounting base and secure with finger-tightened lock nuts.

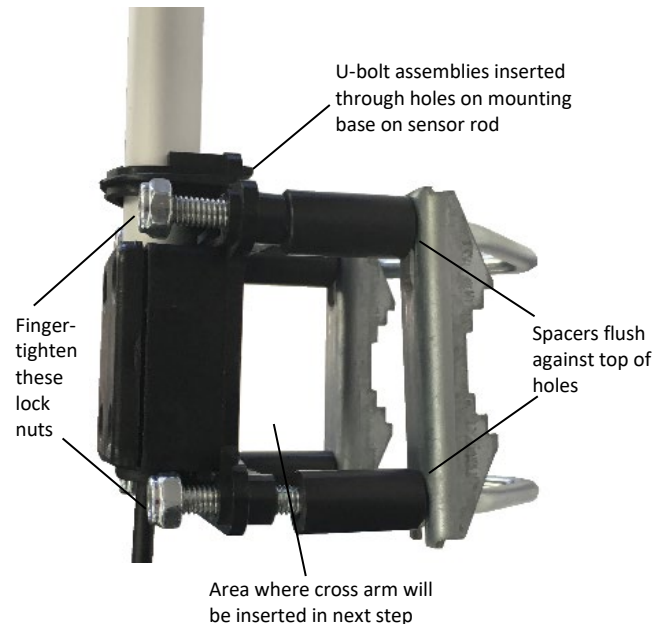

- Slide the assembly above over the end of the cross arm as shown below. Make sure the hole in the cross arm is centered on the sensor mounting base as shown.

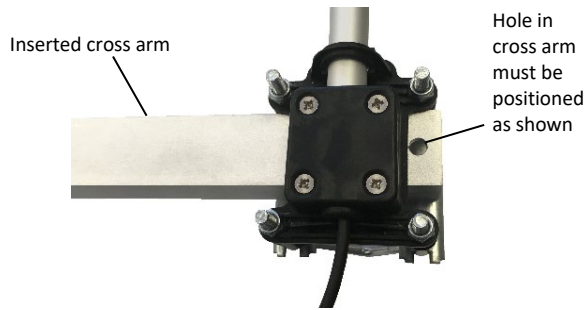

- Make sure the cross arm is flush against the top spacer. The spacer and threaded bolts should be flush against the top of the bracket holes. Tighten the locknuts with a wrench. Do not overtighten them.

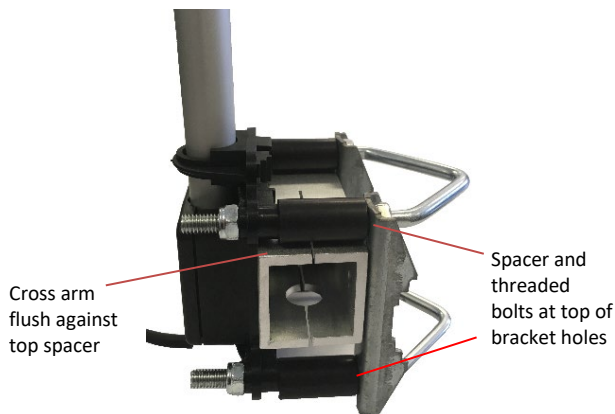

- Follow the steps in *North Alignment* to make sure the sensor is pointed to true north.

Mounting the Sensor on a Vertical Surface

Follow these instructions for mounting the sensor on a wooden post or vertical surface with user-supplied screws.

- Connect the battery if you haven't already done so (see *Connecting the Sensor Battery*).
- Hold the sensor rod base against the surface where you will be mounting the sensor and use a pencil to mark the location of the four screw holes on the base.
- Use a drill with a 5 mm (3/16 inch) drill bit to make pilot holes in these locations.
- Drive four lag screws with a maximum diameter of 6 mm (0.24 inches) through the holes in the sensor base and into the mounting surface.

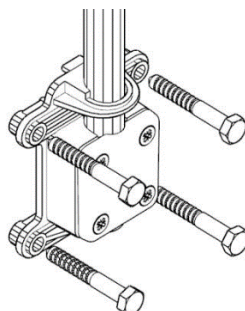

- Follow the steps in *North Alignment* to make sure the sensor is pointed to true north.

North Alignment

The sensor must be oriented to true north to obtain meaningful wind direction data.

Tools required:

- Alignment tool (included)
- GPS or compass
- Flag, cone, or other temporary marker
- Phillips-head screwdriver

- Use a Phillips-head screwdriver to slightly loosen the four screws on the sensor rod mounting base so that the sensor rod can be adjusted. (If the rod already moves freely, you do not need to loosen the screws any further.)

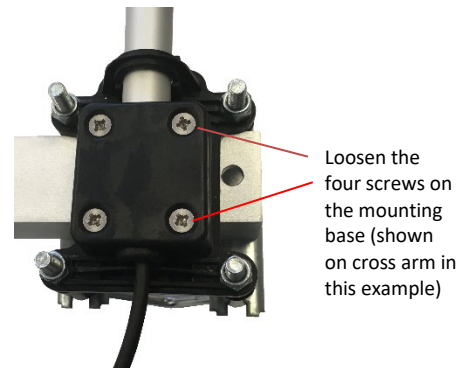

- Clip the alignment tool on the sensor tube and slide it so that it snaps into the dedicated slots. Do not tamper with the slots. The tool must gently find its place.

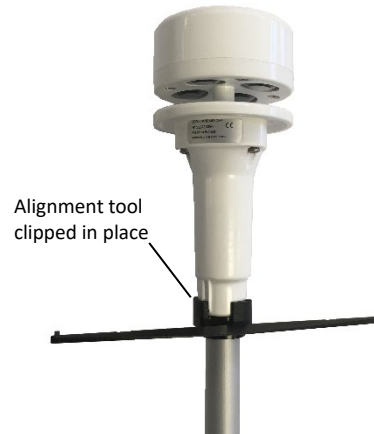

- Using your GPS or a magnetic compass, go to a point that is directly north of the station and at least 100 m (328 ft) away from the station. To determine this point, move until the station is directly south of you.

• **Compass instructions:**

- Get the declination angle for your location to align the sensor to true north. Worldwide declination information is available at <https://www.ngdc.noaa.gov/geomag-web/#declination>.
- Go about 100 m (328 ft) to the north of the station with a marker (e.g. flag or orange cone) and compass.

c. Using the compass, move to where the station is due south of you and determine true north by doing the following:

- If there is a west declination, move due west from your position until the station is east by the declination angle from magnetic south.
- If there is an east declination, move due east from your position until the station is west by the declination angle from magnetic south.

d. Place your marker where you are standing (this is true north).

- **GPS instructions:** Establish a waypoint with the handheld GPS receiver. You may want to use averaging to minimize the waypoint position error if your GPS receiver is so equipped. (For best results, the estimated position error of the waypoint should be less than 10 feet if the distance to the sensor is 100 meters, and less than 20 feet for a distance of 200 meters.) Mark the waypoint with a flag, orange cone, or other suitable marker. Walk back to the sensor and determine the bearing to the waypoint you just created with the GPS receiver. Again you may need to determine the average value of the bearing to keep the errors to a minimum.
4. Use the alignment tool to align the sensor so it is pointing north.

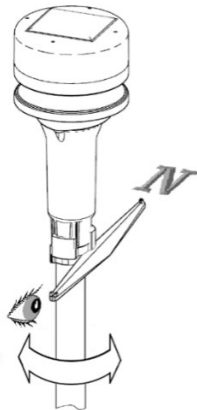

5. Once the sensor is aligned to north, tighten the screws and remove the alignment tool.

Maintenance

The wind speed and direction sensor does not normally require any maintenance other than an occasional cleaning. Use a clean soft cloth with mild soap and fresh water. Do not use alcohol-based cleaning products.

The mote is designed for outdoor use, but should be inspected periodically. When inspecting the mote, do the following:

- Verify the mote is free of visible damage or cracks.
- Make sure the mote is clean. Wipe off any dust or grime with a damp cloth.
- Wipe off any water before opening the mote.
- Make sure the interior seal is intact and the latches are fully locked when the mote door is closed.

Measurement Operation

Wind direction measurements are averaged over the logging interval or a 3-second timeframe (whichever is greater). If you set up the sensor to log faster than every 3 seconds, the same sensor reading will be recorded until a new 3-second average is calculated. For example, if the sensor is logging at a 1-second interval, the sensor will report the same wind direction (its calculated average) for three samples before calculating and reporting a new value for another three samples.

Direction Averaging



Unit vector averaging is used to determine wind direction because traditional averaging would produce inaccurate results. For example, three measurements of 350, 11, and 12 degrees—which are all winds from the north—averaged together would result in 126 degrees, which incorrectly indicates a southeasterly wind. Instead, the vector components (North/South and East/West) for each wind measurement are calculated every three seconds for the duration of the logging interval. At the conclusion of the logging interval, the North/South and East/West components are averaged and then re-combined to calculate the average wind direction for the logging interval.

Verifying Sensor Accuracy

It is recommended that you check the accuracy of the sensor annually. The sensor cannot be calibrated. If the sensor is not providing accurate data, then it is damaged.

Updating Mote Firmware

If a new firmware version is available for the mote, use HOBOLink to download the file to your computer.

1. In HOBOLink, go to Devices, RX Devices, and click your station name.
2. On the station page, click Overview and scroll down to Device Information.
3. Click the Wireless tab. This icon  appears next to the mote if there is a new version of firmware available.
4. Click the firmware  upgrade link. Click Download and save the firmware .bin file to your computer.
5. Connect the mote to the computer with a USB cable (open the mote door and use the USB port to the right of the LCD). The blue LED is illuminated while connected.
6. The mote appears as a new storage device in the computer's file storage manager. Copy the downloaded firmware file to the new storage device (the mote). The blue LED will blink slowly while the file is copying.
7. After the file is copied to the mote, the LED will stop blinking and remain a steady blue. Eject the storage device from the computer and disconnect the cable from the mote. The firmware installation process will begin automatically on the mote. The blue LED will blink rapidly while the firmware is installed. Once the firmware installation is complete, the LCD symbols return and the mote will automatically rejoin the network.

Notes:

- Mac® users: A message may appear indicating the disk has not ejected properly when disconnecting the mote from the computer. The mote is operational and you can ignore the message.
- If the blue LED turns off abruptly while copying the file or installing the firmware, a problem has occurred. Contact Onset Technical Support for help.

Mote Battery Information

The mote uses two 1.2 V rechargeable NiMH batteries, charged by the built-in solar panel. The quality and quantity of solar light can affect whether the battery is sufficiently charged to last through the night and cloudy periods. Make sure the mote is placed in a location that will receive several hours of sunlight each day. If the mote does not receive enough sunlight to recharge the batteries, the battery life is estimated at 3–4 months. When batteries are regularly recharged, expected battery life is estimated at 3–5 years. Battery life varies based on the ambient temperature where the mote is deployed, the logging interval, the number of tripped alarms, and other factors. Deployments in extremely cold or hot temperatures can impact battery life. Estimates are not guaranteed due to uncertainties in initial battery conditions and operating environment.

Mote operation will stop when battery voltage drops to 1.8 V. Mote operation will return if the battery recharges to 2.3 V. If the batteries are unable to be recharged, replace them with fresh rechargeable batteries. **Note:** if you install used rechargeable batteries that together are less than 2.3 V, the mote will not resume operation.

To replace rechargeable batteries:

1. Open the mote door.
2. Remove the old batteries and install fresh ones observing polarity.
3. Make sure the solar panel cable is plugged in.

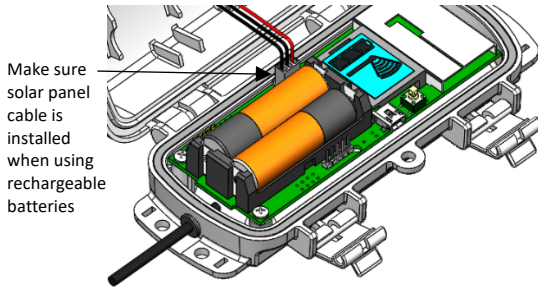

The mote contacts the network once the new batteries are installed. The green LED blinks during this process while the bars in the signal strength indicator on the LCD cycle from left to right and then the x icon blinks. Once this process is complete, the x icon is removed, the green LED stops blinking, and the blue LED begins blinking instead.

Lithium Batteries

You can use two 1.5 V lithium batteries (HWSB-LI) for operation at the extreme ends of the mote operating range. Lithium battery life is an estimated at 1 year, but varies based on the

ambient temperature where the mote is deployed, the logging interval, the number of tripped alarms, and other factors. Estimates are not guaranteed due to uncertainties in initial battery conditions and operating environment. When using lithium batteries, you must disconnect the solar panel cable because the batteries will not be recharged.

To install lithium batteries:

1. Open the mote door.
2. Remove any old batteries and install the new ones observing polarity.
3. Push in the side tab of the solar panel cable connector and pull the connector out of the cable port.
4. Place the connector in the slot on the inside of the mote door. Make sure the solar panel cables are tucked inside the door so that they do not interfere with the interior seal when the mote is closed.

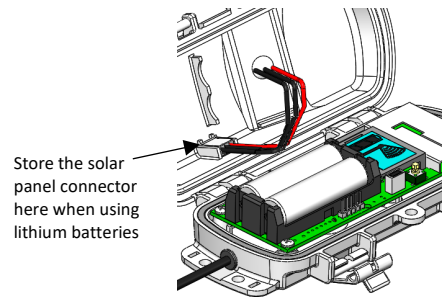

The mote contacts the network once the new batteries are installed. The green LED blinks quickly while the mote searches for a network to join and then blinks slowly while it completes the network registration. Once the mote has finished joining the network, the green LED turns off and the blue LED then blinks indefinitely while the mote is part of the network.

⚠ WARNING: Do not cut open, incinerate, heat above 85°C (185°F), or recharge the lithium batteries. The batteries may explode if the mote is exposed to extreme heat or conditions that could damage or destroy the battery cases. Do not mix battery types, either by chemistry or age; batteries may rupture or explode. Do not dispose of the logger or batteries in fire. Do not expose the contents of the batteries to water. Dispose of the batteries according to local regulations for lithium batteries.

Federal Communication Commission Interference Statement

This equipment has been tested and found to comply with the limits for a Class B digital device, pursuant to Part 15 of the FCC Rules. These limits are designed to provide reasonable protection against harmful interference in a residential installation. This equipment generates uses and can radiate radio frequency energy and, if not installed and used in accordance with the instructions, may cause harmful interference to radio communications. However, there is no guarantee that interference will not occur in a particular installation. If this equipment does cause harmful interference to radio or television reception, which can be determined by turning the equipment off and on, the user is encouraged to try to correct the interference by one of the following measures:

- Reorient or relocate the receiving antenna
- Increase the separation between the equipment and receiver
- Connect the equipment into an outlet on a circuit different from that to which the receiver is connected
- Consult the dealer or an experienced radio/TV technician for help

This device complies with Part 15 of the FCC Rules. Operation is subject to the following two conditions: (1) This device may not cause harmful interference, and (2) this device must accept any interference received, including interference that may cause undesired operation.

FCC Caution: Any changes or modifications not expressly approved by the party responsible for compliance could void the user's authority to operate this equipment.

Industry Canada Statements

This device complies with Industry Canada license-exempt RSS standard(s). Operation is subject to the following two conditions: (1) this device may not cause interference, and (2) this device must accept any interference, including interference that may cause undesired operation of the device.

Avis de conformité pour l'Industrie Canada

Le présent appareil est conforme aux CNR d'Industrie Canada applicables aux appareils radio exempts de licence. L'exploitation est autorisée aux deux conditions suivantes : (1) l'appareil ne doit pas produire de brouillage, et (2) l'appareil doit accepter tout brouillage radioélectrique subi, même si le brouillage est susceptible d'en compromettre le fonctionnement.

To comply with FCC and Industry Canada RF radiation exposure limits for general population, the logger must be installed to provide a separation distance of at least 20cm from all persons and must not be co-located or operating in conjunction with any other antenna or transmitter.

NCC Statement

經型式認證合格之低功率射頻電機，非經許可，公司、商號或使用者均不得擅自變更頻率、加大功率或變更原設計之特性及功能。

低功率射頻電機之使用不得影響飛航安全及干擾合法通信；經發現有干擾現象時，應立即停用，並改善至無干擾時方得繼續使用。前項合法通信，指依電信法規定作業之無線電通信。低功率射頻電機須忍受合法通信或工業、科學及醫療用電波輻射性電機設備之干擾。

Translation:**Article 12**

Without permission granted by the NCC, any company, enterprise, or user is not allowed to change frequency, enhance transmitting power or alter original characteristic as well as performance to an approved low power radio-frequency device.

Article 14

The low power radio-frequency devices shall not influence aircraft security and interfere with legal communications. If found, the user shall cease operating immediately until no interference is achieved. The said legal communications means radio communications is operated in compliance with the Telecommunications Act. The low power radio-frequency devices must be susceptible with the interference from legal communications or ISM radio wave radiated devices.