

## IMF204 Series Redundancy ring network RS-485 to optical fiber converter User Manual

### 【Summarize】

This series of products is a high performance, unmanaged, redundancy ring RS-485 serial to fiber converter, it used in industry application.

It supports point to point two fiber port backup for each other, Fiber line (Ring) transmission, supports 4-channel RS-485 (RS-485 uses 5-pin terminal block) and 1/2-port optical fiber port. The fiber port support redundancy ring function, network fault recovery time < 20ms, it can easy and convenience manage the disperse serial device, take the intelligent redundancy for your network.

It has high performance exchange engine, low consumption design, overload current and voltage protection. It special designed for industry high available data communication in power automation, industry automation, transportation, telecommunication area etc.

It supports wall mounting and DIN--Rail mount installation, easy to use for your projects.

### 【Packing List】

The first time use this product, please check the packaging is intact or not and the attachment is complete or not at first.

- RS-485 to Fiber Converter x 1
- User manual x 1
- 220VAC power cable x 1 (For AC device)
- Certificate card x1
- Warranty card x1
- Mounting brackets x2
- Wall mount kits x2

If you find that the device is damaged or any parts of it is missing during transportation, please notify the Company or the Company's distributor, we will give you proper solution as soon as possible.

### 【Feature】

- Support 4-channel RS-485 serial port
- Support 1/2-port optical fiber
- Support dual(single) Ring line, ST/SC/FC optional
- Support redundancy ring, recovery time < 20ms

- Support 0~115200bps
- Industry grade design, IP30 protection level
- No fan, low consumption design
- Working temperature: -10~70°C

### 【Panel layout】

#### Front view

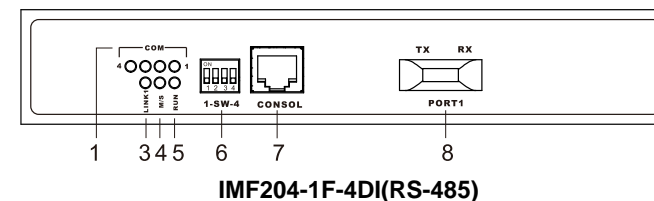
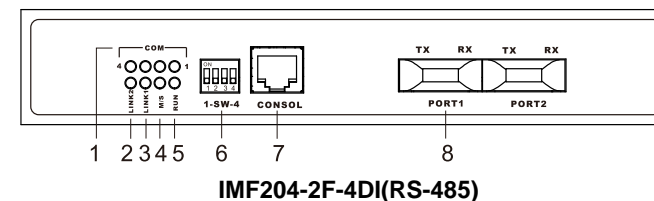

#### Rear view

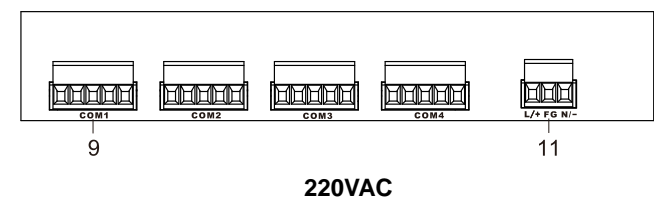
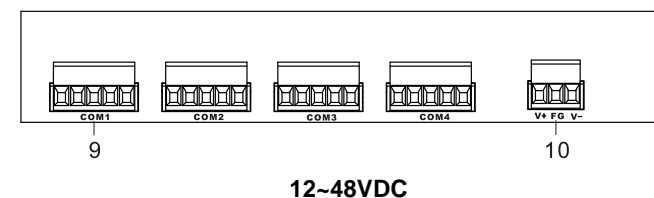

1. COM1-4 serial ports transmit or receive data indicators
2. Fiber port 2 connection status indicator
3. Fiber port 1 connection status indicator
4. Master/slave status indicator
5. Device running status indicator
6. DIP switch

7. CONSOLE port
8. Optical fiber port
9. RS-485 serial ports
10. DC power input terminal block
11. AC power input terminal block

### 【Appearance and Dimension】

Unit (mm)

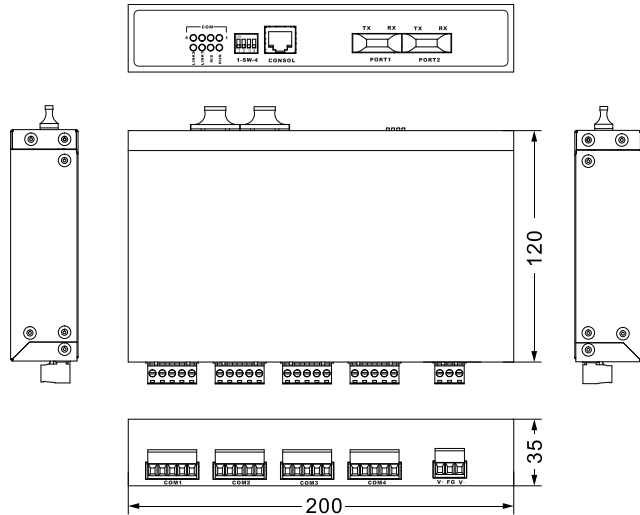

### 【Power supply input】

This series of products includes 2 different type power supply input, the power interface located in rear panel, input power supply: 12~48VDC, 220VAC.

- DC series



Voltage input range is 12~48VDC, terminal block defined as V+, FG, V-.

- AC series



The AC series rear panel provides 3 bit terminal block for

100~240VAC power input (L/+, FG, N/-)

Important notice:

1. Power ON operation: first of all, insert power cable's terminal block into device's power port, then insert power supply plug into power source.
2. Power OFF operation: first off all, unpin power plug, then strike the terminal block, please take care of operation sequence.

### 【DIP Switch】



Front panel provides 4-pin DIP switch to do function configuration (ON is enable). 1 configure master/salve device, "ON" means the master device, "OFF" means the slave device. 2, 3 and 4 is reserved.

### 【Communication Connector】

#### 100M Fiber port

100M full-duplex MM, SM or SS port, SC/ST/FC type .The fiber port must be used in pair, TX (transmit) port connect remote converter's RX (receive) port; RX (receive) port connect remote converter's TX (transmit) port.

The optical fiber connection supports the line to instruct enhance the reliability of network effectively.

**Suppose:** If you make your own cable, we suggest labeling the two sides of the same line with the same letter (A-to-A and B-to-B, shown as below, or A1-to-A2 and B1-to-B2).

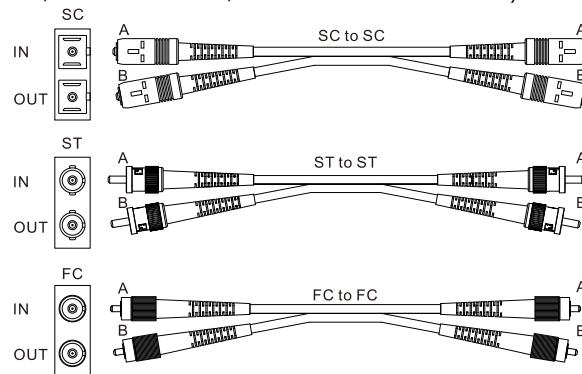

### RS-485 Serial Port

This series of products rear panel provides 5-pin terminal block with 5.08mm separation distance. The PIN defines is as follows:

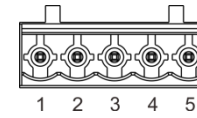

PIN	1	2	3	4	5
Define	D+(A)	D-(B)	GND	Reserved	Reserved

### 【LED Indicator】

This series of products front panel has LED indicator, the function of each LED is described in the table as below:

System status LED		
LED	Indicator	Description
COM1-4	Blinding	RS-485 receive/transmit data regularly
	OFF	RS-485 receive/transmit data un-regularly
RUN	Blinding	System running regularly
	OFF	System running un- regularly or did not running
	ON	System running un- regularly
M/S	ON	Master device
	OFF	Slave device
LINK1-2	ON	Port1/2 established effective connection
	OFF	Port1/2 did not established effective connection

### 【Installation】

Before installation, confirm that the work environment meet the installation require, including the power needs and abundant space. Whether it is close to the connection equipment and other equipment are prepared or not.

1. Avoid in the sunshine, keep away from the heat

- fountainhead or the area where in intense EMI.
2. Examine the cables and plugs that installation requirements.
  3. Examine whether the cables be seemly or not (less than 100m) according to reasonable scheme.
  4. Power:  
DC series product support 12~48VDC power supply;  
AC series product support 100~240VAC power supply;
  5. Environment: working temperature: -10~70°C  
Storage Temperature: -10~70°C  
Relative humidity 5%~95%

### Wiring Requirements

Cable laying need to meet the following requirements,

1. It is needed to check whether the type, quantity and specification of cable match the requirement before cable laying;
2. It is needed to check the cable is damaged or not, factory records and quality assurance booklet before cable laying;
3. The required cable specification, quantity, direction and laying position need to match construction requirements, and cable length depends on actual position;
4. All the cable cannot have break-down and terminal in the middle;
5. Cables should be straight in the hallways and turning;
6. Cable should be straight in the groove, and cannot beyond the groove in case of holding back the inlet and outlet holes. Cables should be banded and fixed when they are out of the groove;
7. User cable should be separated from the power lines. Cables, power lines and grounding lines cannot be overlapped and mixed when they are in the same groove road. When cable is too long, it cannot hold down other cable, but structure in the middle of alignment rack;
8. Pigtail cannot be tied and swerved as less as possible. Swerving radius cannot be too small (small swerving causes terrible loss of link). Its banding should be moderate, not too tight, and should be separated from other cables;

9. It should have corresponding simple signal at both sides of the cable for maintaining.

### 【Specification】

#### RS-485 Serial Port

Channel of RS-485: 4  
RS-485 signal: D+(A), D-(B)  
Parity: None, Even, Odd, Space, Mark  
Data bits: 5bit, 6bit, 7bit, 8bit  
Stop bits: 1bit, 1.5bit, 2bit  
Baud rate: 0bps-115200bps  
Direction: Automatic detect data control  
Loading: 32 nodes  
Transfer distance: 1200m  
Protection: 1.5KVAC isolation  
Connection: 5 bit terminal block

#### Connector

RS-485: 5 bit 5.08mm separation distance terminal block  
Optic fiber port: 100M, SC/FC/ST optional

#### Transmission

RS-485: 1200m  
Multi-mode: 1310nm, 2Km  
Single mode: 1310nm, 20/40/60Km  
1550nm, 80/100/120Km

#### LED indicator

COM1-COM4 running: COM1-COM4  
Device running: RUN  
Master/slave statues: M/S  
Optical fiber port connection statues: LINK1/2

#### Power supply

➤ DC Series:  
Power supply input: 12VDC~48VDC  
No-load consumption: ≤ 2.76W@24VDC  
Full-load consumption: ≤ 2.93W@24VDC  
➤ AC Series:  
Power supply input: 100VAC~240VAC  
No-load consumption: ≤ 3.4W@220VAC  
Full-load consumption: ≤ 3.7W@220VAC

#### Mechanical characteristic

Shell: IP30, metal case  
Installation: Wall mount or DIN-Rail mounts  
Weight: ≤ 690g  
Dimension (L×W×H): 200mm×120mm×35mm

#### Environment

Working temperature: -10°C~70°C  
Storage temperature: -10°C~70°C  
Working humidity: 5%~95%( no condensation)

#### Standard

Shock: IEC 60068-2-27  
Free fall: IEC 60068-2-32  
Shake: IEC 60068-2-6

#### Warranty

Warranty time: 3 years

#### Certification

CE, FCC, RoHS