

V2201 Series

Fanless, ultra-compact x86 IIoT embedded computer and gateway



- > Intel Atom E3800 series processor with three performance options
- > Dual mini-PCIe sockets for wireless modules*, supports W-iFi, 3G, LTE, GPS, and Bluetooth
- > -40 to 85°C system operating temperature (-40 to 70°C with LTE module* installed)
- > Variety of interfaces: 2 serial ports, 2 Ethernet LAN port, 4 DIs, 4 DOs, SD, USB, HDMI, wireless
- > EN 61000-6-2 and EN 61000-6-4 certification**; meets EMC standard for heavy industry
- > Up to 5 Grms anti-vibration and 100 g/11 ms anti-shock
- > Ready-to-run Debian 8 and Windows Embedded Standard 7 platforms
- > Moxa Proactive Monitoring utility for system hardware health monitoring
- > Moxa Smart Recovery utility to recover system from boot failure (W7E only)

*Wireless modules must be purchased separately.

**Passed with AC/DC adapter.



Overview

The Moxa V2201 series ultra-compact x86 embedded computer is based on the Intel® Atom™ E3800 series processor, features the most reliable I/O design to maximize connectivity, and supports dual wireless modules*, making it suitable for a diverse range of communication applications. The computer's thermal design ensures reliable system operation in temperatures ranging from -40 to 85°C (-40 to 70°C with a special purpose Moxa wireless module* installed). The V2201 series supports "Moxa Hardware Monitoring" for device I/O status monitoring and alerts, system temperature monitoring and alerts, and system power management. Monitoring system status closely makes it easier to recover from errors and provides the most reliable platform for your applications.

*Wireless modules must be purchased separately.

Applications:

- Remote Terminal Unit (RTU)
- Data acquisition
- M2M communication (smart gateway)
- Digital signage
- Factory automation
- In-vehicle monitor/data logger (transportation)
- Programmable router
- Energy usage optimization
- Predictive maintenance
- Asset management

Appearance

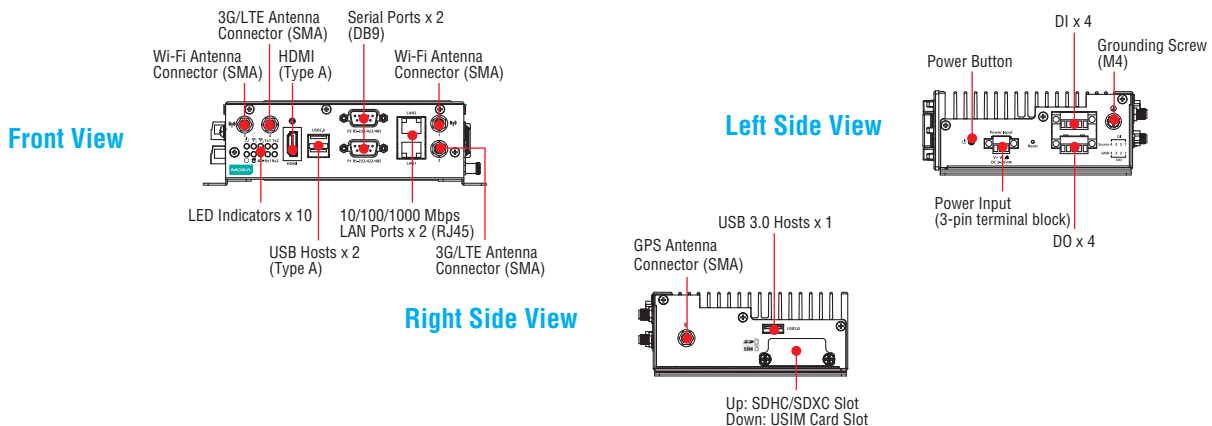

Hardware Specifications

Computer

CPU:

V2201-E1 Series: Intel® Atom™ Processor E3815 (Single Core, 512K Cache, 1.46 GHz)

V2201-E2 Series: Intel® Atom™ Processor E3826 (Dual Core, 1M Cache, 1.46 GHz)

V2201-E4 Series: Intel® Atom™ Processor E3845 (Quad Core, 2M Cache, 1.91 GHz)

OS: Windows Embedded Standard 7 64-bit or Linux Debian 8 64-bit

System Memory: 1 DDR3 SO-DIMM slot, 8 GB max.

- E3815 and E3826 support DDR3L-1066

- E3845 supports DDR3L-1333

USB: 1 bootable USB 3.0 port, 2 bootable USB 2.0 ports (type A)

Storage

mSATA: 1 internal mini-PCIe socket for OS storage

SD: 1 SD 3.0 (SDHC/SDXC) socket for storage expansion*

*W7E only supports SD 2.0

Audio

Output: Line-out interface (together with HDMI)

Other Peripherals

Expansion Slot: 2 Mini-PCIe sockets

- 1 USB signal, for Sierra Wireless 3G/LTE module

- 1 USB + PCIe signal

USIM: 1 USIM slot

Display

Graphics Controller: Intel® HD (integrated)

Connector Type: 1 HDMI connector (type A)

Display Interface: Supports HDMI 1.4a, 1920 x 1080 pixels @ 60/24 Hz

Ethernet Interface

LAN: Auto-sensing 10/100/1000 Mbps ports (RJ45) x 2

Isolation Protection: 1.5 kV

Wireless SMA Interface

Wi-Fi: 2 SMA connectors

3G/LTE: 2 SMA connectors

GPS: 1 SMA connector

Serial Interface

Serial Standards: RS-232/422/485 software selectable ports (DB9 male) x 2

Serial Communication Parameters

Data Bits: 5, 6, 7, 8

Stop Bits: 1, 1.5, 2

Parity: None, Even, Odd, Space, Mark

Flow Control: RTS/CTS, XON/XOFF

Baudrate: 50 bps to 115.2 kbps

Serial Signals

RS-232: TxD, RxD, DTR, DSR, RTS, CTS, DCD, GND

RS-422: TxD+, TxD-, RxD+, RxD-, GND

RS-485-4w: TxD+, TxD-, RxD+, RxD-, GND

RS-485-2w: Data+, Data-, GND

Digital Input

Input Channels: DI x 4

Input Voltage: 0 to 30 VDC at 25 Hz

Digital Input Levels for Dry Contacts:

Logic level 0: Close to GND

Logic level 1: Open

Digital Input Levels for Wet Contacts:

Logic level 1: +3 V max.

Logic level 0: +10 V to +30 V (Source to DI)

Connector Type: 10-pin screw-fastened Euroblock terminal

Isolation: 3 kV optical isolation

Digital Output

Output Channels: DO x 4, sink type

Output Current: Max. 200 mA per channel

On-State Voltage: 24 VDC nominal, open collector to 30 VDC

Connector Type: 10-pin screw-fastened Euroblock terminal

Isolation: 3 kV optical isolation

LEDs

System: Power, user-defined

Storage: mSATA, SD

LAN: 2 LEDs per port (100/1000 Mbps)

Serial: 2 LEDs per port (Tx and Rx)

Wireless: Mini-PCIe 1, Mini-PCIe 2

Switches and Buttons

Power Switch: on/off (left-side panel)

Reset Button: For warm reboot (left-side panel)

Physical Characteristics

Housing: Aluminum

Weight: 940 g (2.09 lb)

Dimensions:

Without ears: 150 x 48.8 x 120.2 mm (5.91 x 1.92 x 4.73 in)

With ears: 178 x 52.5 x 120.2 mm (7.01 x 2.07 x 4.73 in)

Mounting: DIN rail, wall

Environmental Limits

Operating Temperature:

- E1/E2 models: -40 to 85°C (-40 to 185°F)

- E4 models: -40 to 70°C (-40 to 158°F)

- E1-W/E2-W/E4-W models with Moxa recommended wireless modules (3G/LTE + Wi-Fi)* installed: -40 to 70°C (-40 to 158°F)

*Wireless modules must be purchased separately.

Storage Temperature: -40 to 85°C (-40 to 185°F)

Ambient Relative Humidity: 5 to 95% (non-condensing)

Anti-Vibration: IEC 60068-2-64: 5 Grms, 5 Hz to 500 Hz, 1 hr/axis w/ mSATA, SD

Anti-Shock: IEC 60068-2-27: 100 g/11 ms ±X, ±Y, ±Z, 3 shocks each axis w/ mSATA, SD

Power Requirements

Input Voltage: 9 to 36 VDC (3-pin terminal block for V+, V-, SG)

Input Current: 2 A @ 9 VDC

Power Consumption: 18 W

Standards and Certifications

Safety: UL 60950-1, CSA C22.2 No. 60950-1-03 (60950-1-07), EN 60950-1, UL 508

EMC: EN 55032/24, EN 61000-6-2/6-4*

*Passed with AC/DC adapter.

EMI: CISPR 32, FCC Part 15B Class A

EMS:

IEC 61000-4-2 ESD: Contact: 6 kV; Air: 8 kV

IEC 61000-4-3 RS: 80 MHz to 1 GHz: 20 V/m

IEC 61000-4-4 EFT: Power: 2 kV; Signal: 2 kV

IEC 61000-4-5 Surge: Power: 2 kV; Signal: 1 kV

IEC 61000-4-6 CS: 10 V

IEC 61000-4-8

Green Product: RoHS, CRoHS, WEEE

Reliability

Automatic Reboot Trigger: Software-programmable watchdog timer configurable from 1 to 255 seconds

MTBF (mean time between failures)

Time: 408,275 hrs

Standard: Telcordia (Bellcore) Standard TR/SR

Warranty

Warranty Period: 3 years

Details: See www.moxa.com/warranty

Note: These hardware specifications describe the embedded computer unit itself, but not its official accessories. In particular, the wide temperature specification does not apply to accessories such as power adapters and cables.

Software Specifications

Linux

OS: Linux Debian 8 64-bit

Terminal Server (SSH): Provides secure encrypted communications between two untrusted hosts over an unsecure network

File System: EXT2, EXT3, EXT4

Internet Protocol Suite: TCP, UDP, IPv4, IPv6, SNMPv2, ICMP, ARP, HTTP, CHAP, PAP, DHCP, NTP, NFS, SSH, PPP, SFTP, RSYNC, SSL

Internet Security: OpenVPN, IPTables

Secure Shell for Remote Access: SSH allows remote logins to a secure encrypted console from any connected network

Watchdog: Features a hardware function to trigger system reset in a user specified time interval (Linux standard API)

Embedded Self-Health Maintenance Software: Moxa Proactive Monitoring

Windows Embedded Standard 7

Core OS:

- 64-bit support
- Remote Client
- Remote Procedure Call

Applications and Services Development:

- Remote Desktop Protocol 7.1
- COM OLE Application Support
- COM+ Application Support
- MSMQ

Internet Services:

- Internet Explorer 8.0
- IIS 7.0

Diagnostics:

- Common Diagnostic Tools
- Problem Reports and Solutions

Fonts: Western, Middle Eastern, South East Asian, and South Asian

Graphics and Multimedia:

- MPEG Layer-3 Audio Codecs (MP3)
- MPEG4 Decoders
- DirectX and Windows Device Experience

Management:

- Group Policy Management
- Windows Management Instrument (WMI)
- Windows Update

Networking:

- Extensible Authentication Protocol (EAP)
- Internet Authentication Service
- Telnet Server
- Bluetooth
- Domain Services
- Network Access Protection
- Network and Sharing Center
- Quality of Service
- Remote Access Service (RAS)
- Telephony API Client
- Windows Firewall
- Wireless Networking

Security:

- Credential Roaming Service
- Credentials and Certificate Management
- Windows Authorization Manager (AZMAN)
- Windows Security Center
- Active Directory Rights Management
- Security Base
- Encrypted File System (EFS)

Embedded Features:

- Enhanced Write Filter (EWF)
- File-Based Write Filter (FBWF)
- Registry Filter
- WSDAPI for .NET

File Systems and Data Store:

- Windows Data Access Components
- Windows Backup and Restore









Maintenance: Moxa Proactive Monitoring and Moxa Smart Recovery

Optional Accessories (can be purchased separately)

Type	Model Name	Description	
Power			
	Adapter	PWR-24270-DT-S1	Power adapter, input voltage 90 to 264 VAC, output voltage of 24 V with 2.5 A DC load
	Power Cord	PWC-C7US-2B-183	Power cord with 2-pin connector, USA plug
	Power Cord	PWC-C7EU-2B-183	Power cord with 2-pin connector, Euro plug
	Power Cord	PWC-C7UK-2B-183	Power cord with 2-pin connector, British plug
	Power Cord	PWC-C7AU-2B-183	Power cord with 2-pin connector, Australia plug
	Power Cord	PWC-C7CN-2B-183	Power cord with 2-pin connector, China plug
Mounting Kit			
	DIN-Rail Mounting Kit	DK-DC50131	DIN-rail mounting kit x 1, screws x 6

Wireless Accessory Packages

Note: The following packages can be purchased separately without the computer

Type		Model Name	Description
Wi-Fi			
	Mini-PCIe Card	V2201 Wi-Fi mini Card	SparkLAN WPEA-252NI Wi-Fi mini cards x 1, black screws x 4
	External Antenna	ANT-WDB-ARM-02	Wi-Fi external antenna with SMA connectors x 1
3G			
	External Antenna	ANT-WCDMA-ASM-1.5	3G external antenna with SMA connectors x 1
LTE			
	Mini-PCIe Card	V2201 LTE-US mini card	Sierra Wireless MC7354 LTE mini cards x 1, black screws x 4
	Mini-PCIe Card	V2201 LTE-EU mini card	Sierra Wireless MC7304 LTE mini cards x 1, black screws x 4
	LTE-US External Antenna	ANT-LTEUS-ASM-01	LTE-US external antenna with SMA connectors x 1
	LTE-EU External Antenna	ANT-LTE-ASM-02	LTE-EU external antenna with SMA connectors x 1
GPS			
	GPS External Antenna	ANT-GPS-OSM-05-3M	26 dBi, 1572 MHz, L1 band SMA antennas x 1, for the MC7354 and MC7304 only