

VPort 25 Series

IP66, day-and-night vandal-proof fixed dome IP camera for outdoors



- > -40 to 50°C operating temperature; heater or fan not required
- > IP66-rated for protection from rain and dust
- > Direct-wired power input and PoE for power redundancy
- > Up to 30 frames/sec at 720 x 480 resolution
- > One camera lens for both day and night use

The certification logos shown here apply to some or all of the products in this section. For details, see "Regulatory Approvals" under "Specifications" below.



Introduction

The VPort 25 is a vandal-proof, IP66-rated, fixed dome IP camera for use in harsh, outdoor environments. With maximum resolution of 520 TVL and day-and-night CCD camera lens, the VPort 25 is especially well-suited for high performance video surveillance applications. To meet the outdoor environment requirements, the VPort 25 is IP66-

rated to protect it against dust and rain. In addition, the vandal-proof form factor design prevents damage from unexpected external forces, and the case-open sensor sends an alarm message when the VPort 25's outer case is opened.

Heater and fan not required, supports direct-wired power input and PoE for power redundancy

The VPort 25's no-heater/fan-less embedded system provides greater reliability for outdoor use. In addition, the camera comes with

redundant power inputs: (1) direct power connection (12/24 VDC and 24 VAC), and (2) PoE (IEEE 802.3af) power input.

High performance video, with full motion MJPEG/MPEG4 video stream

The VPort 25 uses the ASIC compression chip, which provides video performance up to full D1 (720 x 480) @ 30 FPS. To meet a wider

range of customer requirements, the VPort 25 supports dual-codecs, including the MJPEG and MPEG4 algorithms.

Specifications

Camera

Sensor: 1/3" Sony Super HAD or 1/3" Sony ExView

Lens:

Wide-end: F1.4, diagonal 115.4°, horizontal 90.3°

Tele-end: F2.4, diagonal 39.8°, horizontal 31.9°

Focal Length: F= 3.7-12 mm

Modulation: NTSC or PAL

Camera Angle: Pan: ±180°; tilt: ±85°, rotation: ±170° (camera angles controlled manually)

Illumination:

Color: 0.2 Lux at F1.2

Black and white: 0.03 Lux at F1.2

Synchronization: Internal

Gamma Correction: 0.45

White Balance: Auto tracking white balance

Electronic Shutter Speed: 1/60 (50) second to 1/100,000 second, automatic

S/N Ratio: More than 50 dB (AGC off)

AGC Control: On/Off

Flickerless Control: On/Off

Backlight Compensation: On/Off

Mirror: On/Off

Auto Exposure, Auto Iris:

On: Auto exposure

Off: Auto iris

Horizontal Resolution: 420/520 TVL

Effective Pixels:

NTSC: 510 x 492 (middle resolution), 768 x 494 (high resolution)

PAL: 500 x 582 (middle resolution), 752 x 582 (high resolution)

Video

Video Compression: MJPEG or MPEG4 (ISO/IEC 14496-2)

Video Resolution:

	NTSC		PAL	
	Size	Max. FPS	Size	Max. FPS
QVGA	320 x 240	30	320 x 288	25
CIF	352 x 240	30	352 x 288	25
VGA	640 x 480	30	640 x 576	25
4CIF	704 x 480	30	704 x 576	25
Full D1	720 x 480	30	720 x 576	25

Video Viewing:

- Adjustable image size and quality
- Timestamp and text overlay

Video Output: Via Ethernet port or BNC connector (1.0 Vpp, 75 ohms)

Audio

Audio Input: 1 Line-in or MIC-in with 2-pin terminal block connector

Audio Output: 1 Line-out with 2-pin terminal block connector

Network

Protocols: TCP, UDP, HTTP, SMTP, FTP, Telnet, NTP, DNS, DHCP, UPnP, RTP, RTSP, ICMP, IGMPv3, QoS, SNMPv1/v2c/v3, DDNS
Ethernet: 1 10/100BaseT(X) auto negotiating RJ45 port

GPIO

Digital Inputs: 1, max. 8 mA
 • High: +13 to +30V
 • Low: -30 to +3V

Relay Output: 1, max. 24 VDC @ 1A

LED Indicators

STAT: Indicates if the system booted properly
Network: 1 LED for 10 Mbps, 1 LED for 100 Mbps
System: Power On/Off

DIP Switch: To turn the LED light On/Off

Power Requirements

Input Voltage: Redundant power inputs
 • 12/24 VDC or 24 VAC with 2-pin terminal block connector
 • Power-over-Ethernet (IEEE 802.3af)

Physical Characteristics

Housing: IP66-rated for rain and dust protection, vandal-proof supports
Dimensions: 142 x 118.9 mm (5.60 x 4.68 in)
Weight: 1100 g
Installation: Surface mounting, wall mounting

Alarms

Video Motion Detection: Includes sensitivity tuning
Video Loss: Video loss alarm
Case-open Sensor: Built in case-open sensor alarm
Scheduling: Daily repeat timing schedule
Imaging: JPEG snapshots for pre/trigger/post alarm images
Custom Alarms: HTTP event servers for setting customized alarm actions

Security

Password: User level password protection
Filtering: By IP address

Dimensions (unit = mm)

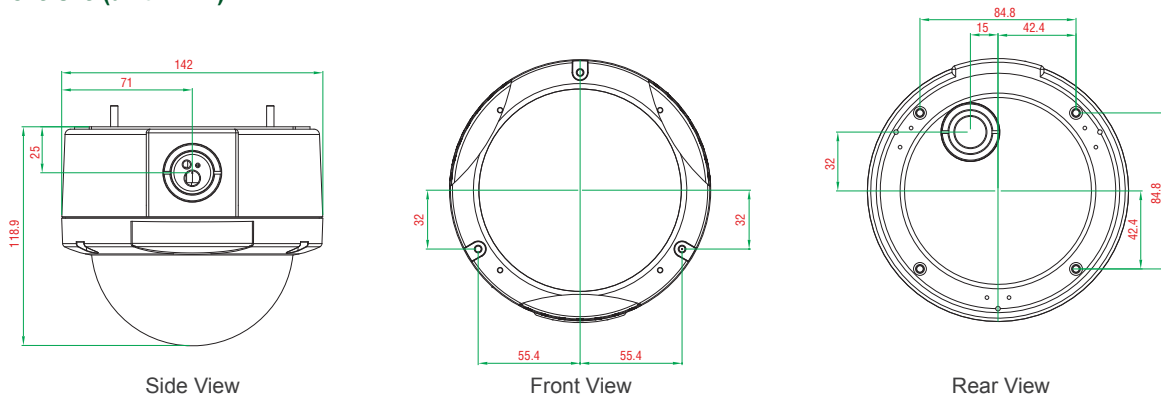

Environmental Limits

Operating Temperature: -40 to 50°C (-40 to 122°F)
Storage Temperature: -40 to 85°C (-40 to 185°F)
Ambient Relative Humidity: 5 to 95% (non-condensing)

Regulatory Approvals

Safety: UL508 (Pending)
EMS:
 EN61000-4-2 (ESD), level 2
 EN61000-4-3 (RS), level 3
 EN61000-4-4 (EFT), level 3
 EN61000-4-5 (Surge), level 3
 EN61000-4-6 (CS), level 3
 EN61000-4-12 (Oscillatory wave immunity), level 3
EMI: FCC Part 15, CISPR (EN55022) class A

Shock: IEC 60068-2-27

Freefall: IEC 60068-2-32

Vibration: IEC 60068-2-6

Note: Please check Moxa's website for the most up-to-date certification status.

Warranty

Warranty Period: 1 year
Details: See www.moxa.com/warranty

System Requirements

CPU: Pentium 4, 2.4 GHz or above
Memory: 512 MB memory or above
OS: Windows XP/2000 with SP2 or above
Browser: Internet Explorer 6.x or above
Multimedia: DirectX 9.0c or above

Software Bundled Free

SoftDVR™ Lite: 1 to 4-ch IP surveillance software for viewing and recording
VPort SDK PLUS: Includes CGI commands, ActiveX Control, and API library for customized applications or system integration for third-party developers (the latest version of SDK is available for download from Moxa's website).

Ordering Information

Available Models	Camera Sensor		Modulation	
	SuperHAD	Exview	NTSC	PAL
VPort 25-CAM3S52N	√	---	√	---
VPort 25-CAM3S52P	√	---	---	√
VPort 25-CAM3E52N	---	√	√	---
VPort 25-CAM3E52P	---	√	---	√

: IP Camera Mounting Accessories



Mounting Kit

For mounting dome camera onto straight tube, gooseneck tube, or mini pendant

VP-MK

Height: 71 mm (2.8 in)
Diameter: 132.4 mm (5.21 in)
Weight: 300 g (0.7 lbs)

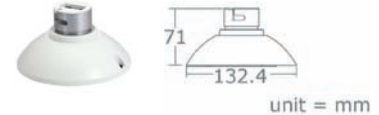

Straight Tube

VP-ST1 or VP-ST2

Height: 250 mm (9.84 in) or 500 mm (19.69 in)
Diameter: 50 mm (1.97 in)
Weight: 1000 g (2.2 lbs)/1800 g (4 lbs)

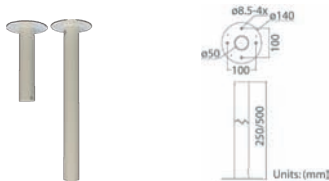

Gooseneck Tube

VP-GT

Dimensions: 323 x 385 mm (11.73 x 15.16 in)
Diameter: 92 x 42 mm (3.62 x 1.65 in)
Weight: 2100 g (4.6 lbs)

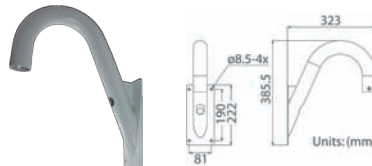

Mini Pendant

VP-MP

Dimensions:
 184 x 104 x 115.2 mm (7.24 x 4.09 x 4.54 in)
Diameter: 44.5 mm (1.75 in)
Weight: 600 g (1.3 lbs)

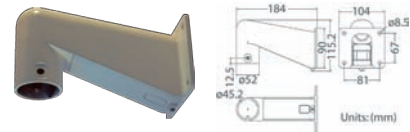

Wall Box Mounting

For mounting gooseneck and mini pendants on a wall

VP-WBM

Dimensions:
 270 x 166 x 95 mm (10.63 x 6.54 x 3.74 in)
Weight: 2200 g (4.8 lbs)

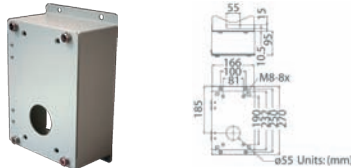

Standard Corner Mounting Plate

For mounting gooseneck and mini pendants in a corner

VP-CST

Dimensions:
 222 x 204 x 117 mm (8.74 x 8.03 x 4.61 in)
Weight: 2000 g (4.4 lbs)

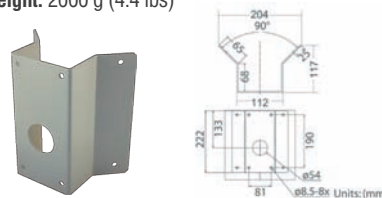

Mini Corner Plate

For mounting gooseneck and mini pendants in a corner

VP-CSTM

Dimensions:
 270 x 166 x 95 mm (10.63 x 6.54 x 3.74 in)
Weight: 800 g (1.8 lbs)

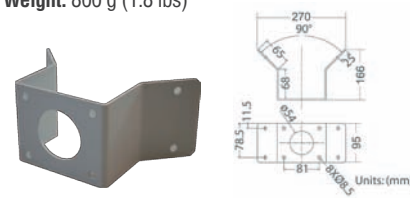

Outdoor Thin Pole Direct Mounting

For mounting gooseneck and mini pendants on a pole

VP-PTD

Dimensions:
 232 x 136 x 50 mm (9.13 x 5.35 x 1.97 in)
Recommended Pole Diameter:
 112 to 140 mm (4.4 to 5.5 in)
Weight: 700 g (1.6 lbs)

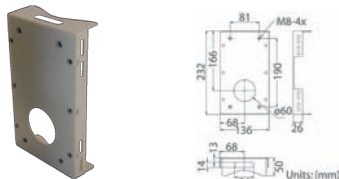

Outdoor Wide Pole Direct Mounting

For mounting gooseneck and mini pendants on a pole

VP-PWD

Dimensions:
 270 x 170 x 60 mm (10.63 x 6.69 x 2.36 in)
Recommended Pole Diameter:
 112 to 130 mm (4.4 to 5 in)
Weight: 1000 g (2.2 lbs)

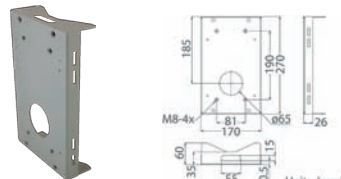

Stainless Steel Straps

For direct pole mounting or mounting a pole box on a pole

VP-SS1

Length: 700 mm (27.56 in)
Width: 16 mm (0.63 in)
Weight: 20 g (0.04 lbs)
Note: Four straps are shipped with each order

